

2kw Electric Heater

Model Number BM-06 22" Pryzm (Patent Pending)

Model Number 2785 22"-16" Chollerton

Model Number 1584 Ember MKII

User / Installation instructions

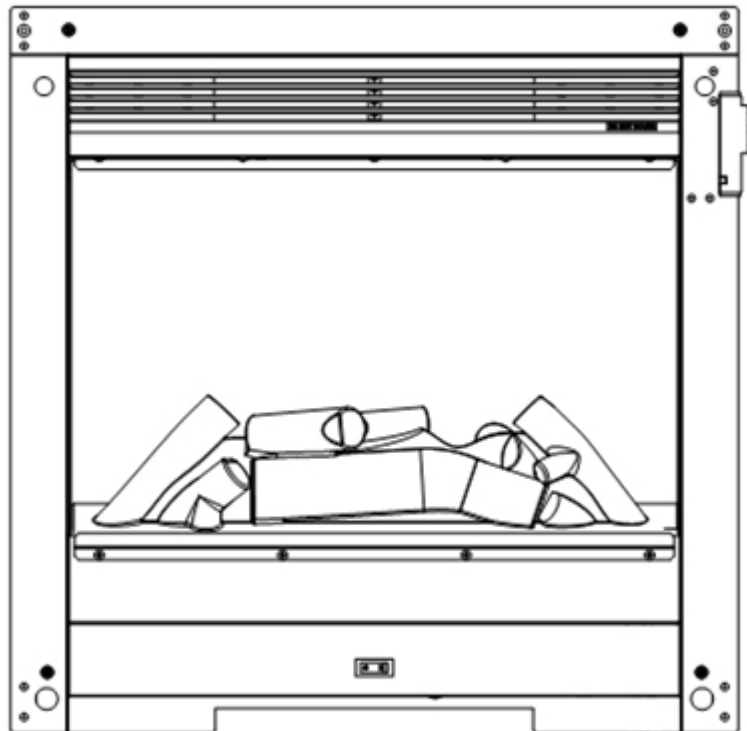

These instructions should be read carefully and retained for future reference.

CONTENT

| | |
|--------------------------------------|---------|
| Important Notes | 3 |
| Technical Specification | 4 |
| Parts List | 5 |
| Fire Installation | 6 - 8 |
| Operation by Manual Control | 9 |
| Operation by Remote Control | 10 – 16 |
| Safety Thermal Cut-Out / Maintenance | 17 |
| Electric Fire Guarantee | 18 |
| General Information | 19 |

IMPORTANT NOTES

For indoor use only this appliance is not suitable for use outside the house and only suitable for well insulated spaces or occasional use.

Do not use this appliance as a primary heat source.

This heater must not be located immediately below a fixed socket outlet.

Do not use the heater in the immediate surrounds of a bath, a shower, or a swimming pool or any wet area.

The meaning of this figure  shown on the front of the appliance is **WARNING: "DO NOT COVER"**.

Do not cover this heater, or obstruct the air inlet or outlet, otherwise there is a risk of overheating.

Ensure that furniture, curtains and other combustible materials are positioned no closer than 1m from the front of the appliance.

This heater must be fixed against a vertical surface.

If this appliance's power is supplied through an extension cable, please ensure that it is the only appliance plugged into the extension cable and that the instructions for the extension cable / reel are followed.

If the supply cord is damaged, it must be replaced by the manufacturer, its service agent or similarly qualified persons in order to avoid a hazard.

CAUTION: In order to avoid a hazard due to inadvertent resetting of the thermal cut out, this appliance's power must not be supplied through an external switching device, such as a timer, or connected to a circuit that is regularly switched on and off by the utility.

This appliance must be positioned so that the plug / fused spur is accessible. In the event of a fault please disconnect the appliance from the mains supply. Warning: This appliance must be earthed

The heater must be cooled down completely before any maintenance.

After unpacking, please make sure that the appliance is intact, with no signs of damage caused by transport. If in doubt, do not use the appliance and contact the Service Centre.

During normal operation this appliance will emit noise from the internal fan unit.

Children should be supervised to ensure that they do not play with the appliance or remote control.

Children of less than 3 years should be kept away unless continuously supervised.

Children aged from 3 years and less than 8 years shall only switch on/off the appliance provided that it has been placed or installed in its intended normal operating position and they have been given supervision or instruction concerning use of the appliance in a safe way and understand the hazards involved.

Children aged from 3 years and less than 8 years shall not plug in, regulate and clean the appliance or perform user maintenance.

This appliance can be used by children aged from 8 years and above and persons with reduced physical, sensory or mental capabilities or lack of experience and knowledge if they have been given supervision or instruction concerning use of the appliance in a safe way and understand the hazards involved. Cleaning and user maintenance shall not be made by children without supervision. Do not use this appliance in small rooms when they are occupied by persons not capable of leaving the room on their own, unless constant supervision is provided.

Children and vulnerable people must be supervised at all times when using this appliance, as some parts can become very hot.

TECHNICAL SPECIFICATION

Model NO.:BM06 – Elec, 2785, 1584

Supply Voltage:AC220V-240V 50Hz

Maximum power consumption:2KW

Heat output:

Nominal heat output (Pnom): 2KW

Minimum heat output (indicative) (Pmin): 1KW

Maximum continuous heat output (Pmax): 2KW

Auxiliary Electricity Consumption:

At nominal heat output (elmax): 12.5W

At minimum heat output (elmin): 12W

In standby mode (elSB): 0.36W

Type of heat output / room temperature control

| | |
|--------------------------------------------------------|-----|
| Two or more manual stages, no room temperature control | No |
| With mechanic thermostat room temperature control | No |
| With electronic room temperature control | Yes |
| Electronic room temperature control plus day timer | Yes |
| Electronic room temperature control plus week timer | Yes |

Other control options

| | |
|------------------------------------------------------|-----|
| Room temperature control, with presence detection | No |
| Room temperature control, with open window detection | Yes |
| With distance control option | No |
| With adaptive start control | Yes |
| With working time limitation | No |
| With black bulb sensor | No |

PART LIST

Please unpack carefully ensuring that any loose parts and all packing items are removed. Read any warning labels carefully (see Maintenance Section). Place waste packaging back into box and dispose of RESPONSIBLY.



Please recycle where facilities exist. Check with your local authority for recycling advice

- | | |
|-----------------------|-----|
| 1. Instruction Manual | 1pc |
| 2. Remote Control | 1pc |
| 3. AAA Batteries | 2pc |

22" Pryzm – Model number BM06 (Patent Pending)

- | | |
|--------|-----|
| • Trim | 1pc |
|--------|-----|

22"- 16" Chollerton – Model number 2785

- | | |
|--------|-----|
| • Trim | 1pc |
|--------|-----|

Ember MKII – Model number 1584

- | | |
|--------|-----|
| • Trim | 1pc |
| • Fret | 1pc |

FIRE INSTALLATION BM-06 22" Pryzm (Patent Pending)

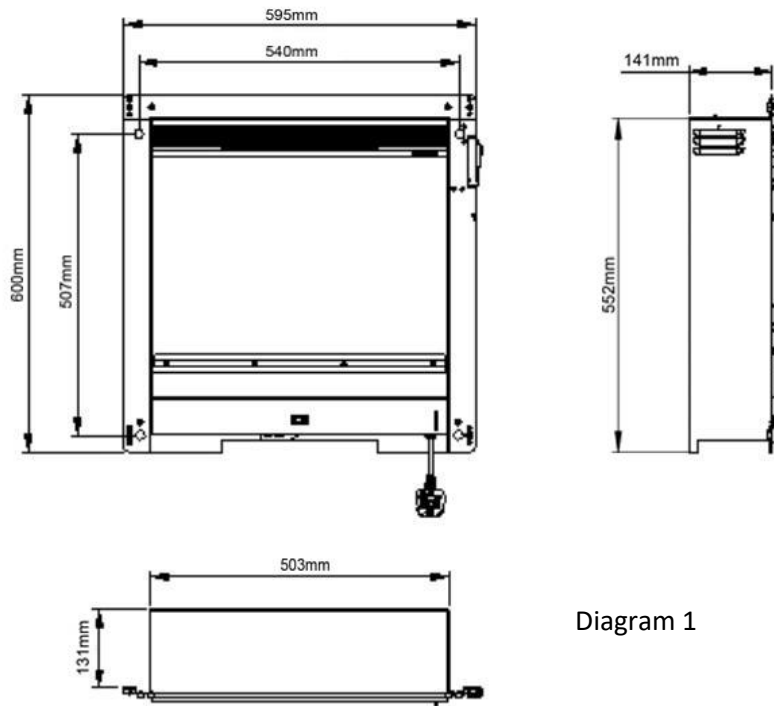

FIRE INSTALLATION Model Number 2785 22" – 16" Chollerton (Patent Pending)

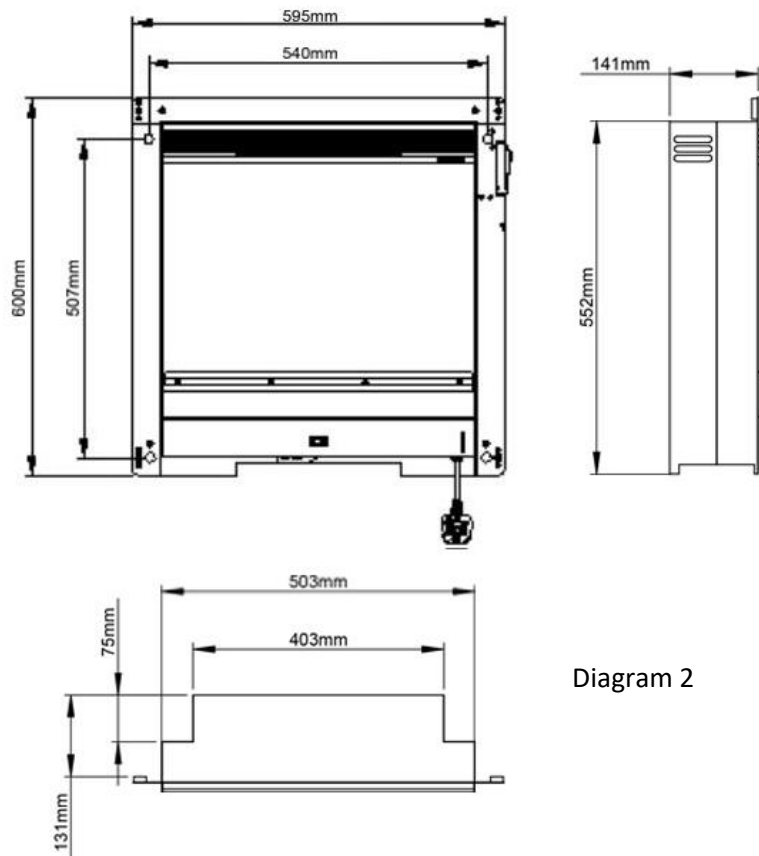

FIRE INSTALLATION Model Number 1584 Ember MKII

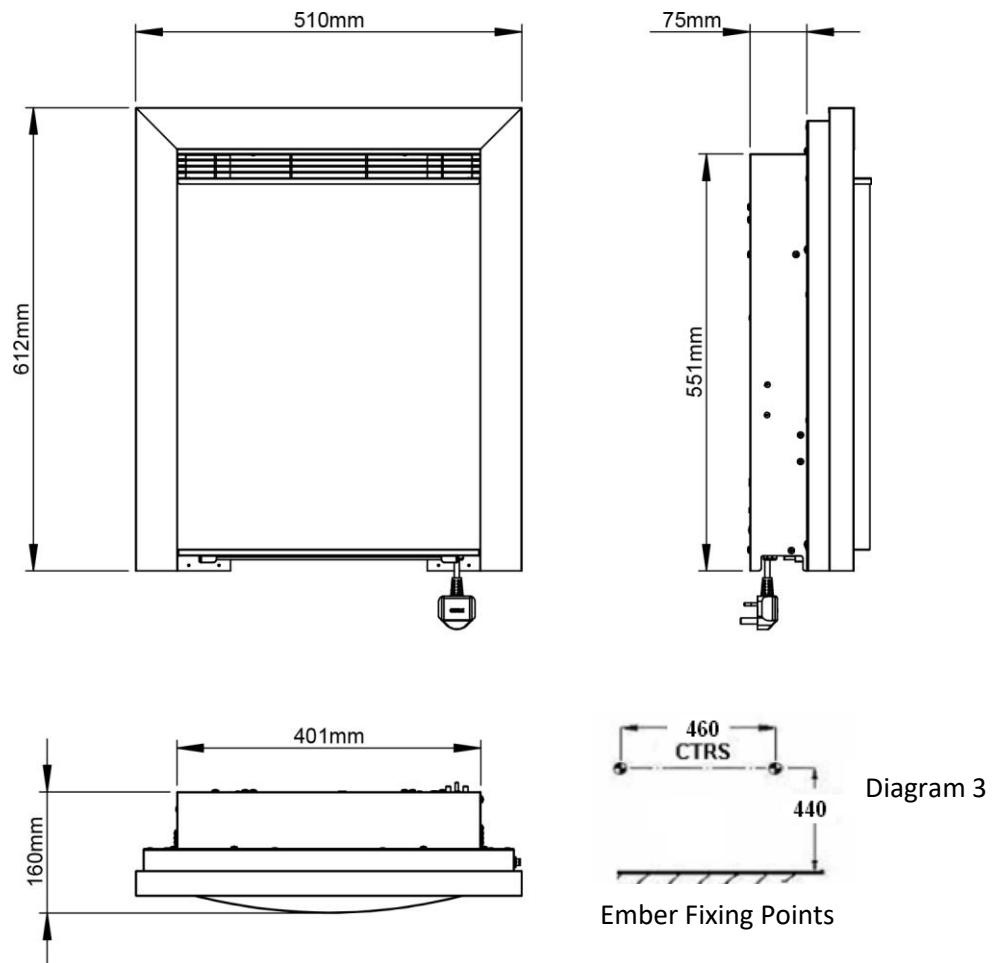

Before You Start

Required for installation: 4 off screws and plugs suitable for the wall media (Not supplied)

The surround / appliance must be positioned so that the plug (fused spur) is accessible. Only when you are certain that you have completed the installation should you plug in and switch on at the wall socket.

This appliance should not be installed into an open / existing fireplace without the opening being professionally blanked off to reduce the risk of a back draught, which could cause the safety cut-out to operate.

Check that the supply voltage details on the appliance are in accordance with your electrical supply. Your appliance is fitted with a plug incorporating a 13 Amp fuse. In the event of replacing the fuse in the plug supplied, a 13 Amp fuse approved by ASTA to BS 1362 must be used. Before switching on, please read the following fire installation instructions.

In the event of any problems please contact: **Be-Modern Helpline on 0191 430-0901.**

Recommended Suite Installation Dimensions

| Model | A | B | C |
|----------------------------------------------------------|--------------------|--------------------|---------|
| BM-06 (22" Pryzm) (Patent Pending) | 565 min 590 max | 513 min 570 max | 145 min |
| 2785 (22" – 16") Chollerton Flat wall fix with spacer | 565 min 590 max | 413 min 570 max | 75 min |
| Fully inset no spacer | 565 min 590 max | 513 min 570 max | 145 min |
| 1584 Ember MK II | 565 min 590 max | 413 min 470 max | 75 min |

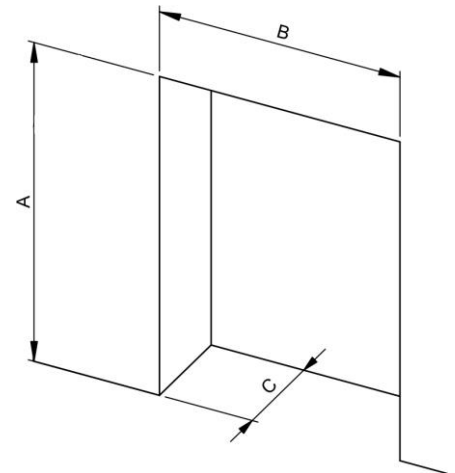

Recess dimensions: (unit: mm)

Installation

22" and 22"-16" Chollerton models BM-06 and 2785

- Ensure that the mains power is isolated to the appliance plug / socket point.
- Offer the fire into the opening
- Mark on the wall the positions of the fixing points on the side flanges of the fire. See diagram 1 and 2.
- Remove the fire from the opening.
- Drill and plug the wall holes using suitable fixings.
- Connect the appliance to the plug / socket.
- Offer the appliance back into the opening and using suitable screws fix the appliance in position.
- Fit the trim to the magnets provided on the fire.
- Restore power to the plug / socket.

Ember model 1584

- Carefully mark out the hole positions in a central position. Drill and plug fixing holes as shown in diagram 3 (please ensure correct plugs for the wall / back panel medium are used).
- Fit two pan head screws (No.8 x Min 25 long not supplied) leaving approximately 2mm between the wall and the screw head
- Lift the fire in to the aperture cable side first, moving from the left, taking great care not to damage either the cable or hearth. Once the cable side of the fire is in position, lift the fire in to a central position opposite the retaining screws.
- Lift the fire up and hook the keyhole slots on to the retaining screws. Please note that to ensure a snug fit against the wall the screw heads as mentioned in section 1 can be adjusted in or out

OPERATION BY MANUAL BUTTON

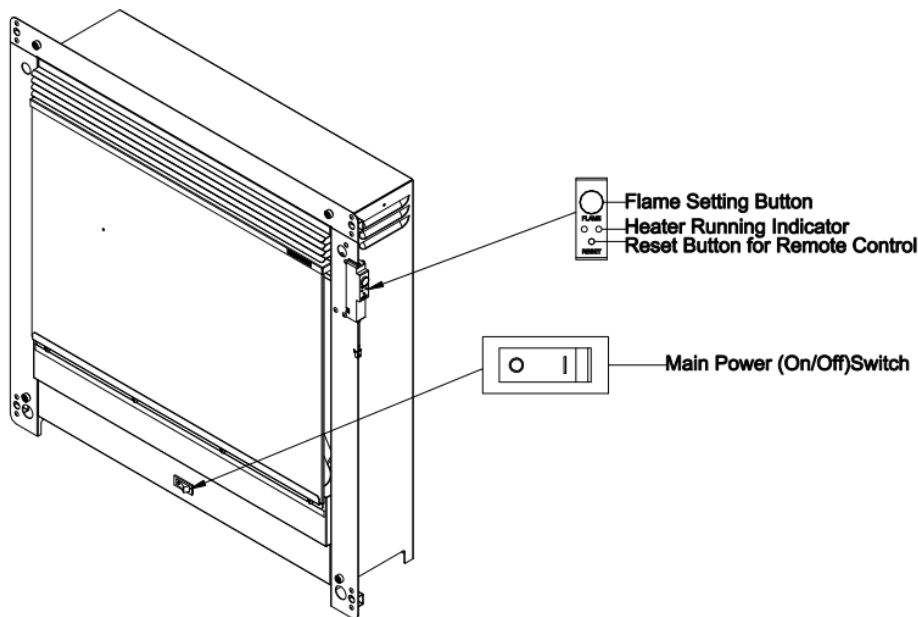

MAIN POWER (ON / OFF) SWITCH:

The main switch is on the bottom front of the appliance, and it supplies power to all of the functions of the fireplace. This switch must be in the “ON” position for any of the functions (including the remote) to work.

FLAME SETTING BUTTON:

By pressing the FLAME button, the unit will cycle through four flame effect (high, middle, low, off)

HEATER RUNNING INDICATOR:

If the appliance heater is running and the flame and mood light are turned off, the heater running indicator light is always on. If the appliance heater is running and the flame or mood light is turned on, the heater running indicator will be extinguished after 10 seconds.

RESET BUTTON FOR THE REMOTE CONTROL:

If the appliance operates incorrectly or the appliance cannot be controlled by the remote, the RESET button is used to reset the communication between the remote and the appliance. Check section **OPERATION BY REMOTE CONTROL-R30** for more details.

OPERATION BY REMOTE CONTROL

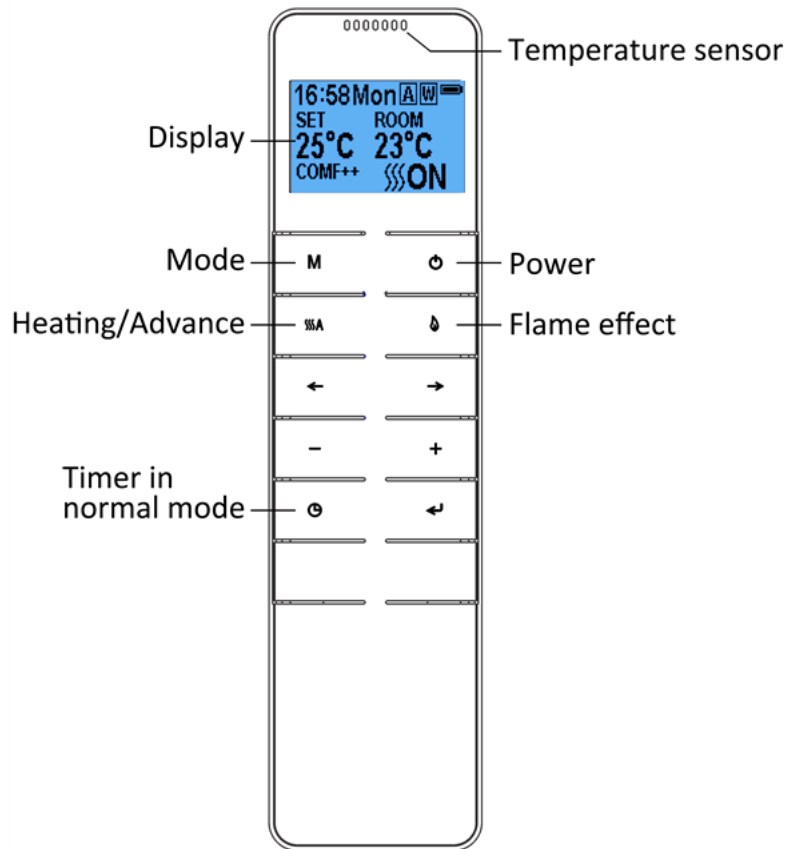

NOTE: This is a thermostatic remote control. The remote should be in the same room as the appliance and placed on a flat surface. It must be placed away from the appliance so the hot air will not blow on it and affect the thermostatic reading.

The communication frequency between the appliance and remote has already been set up. If you cannot use the remote with the appliance, please follow instruction Step. R29 to initiate this connection

Standby for Remote Handset

R1 The image shown to the right is when the remote handset is in standby mode.



Before Day / Time set

Turn on / off

R2 Press to turn on / off the flame effect and heater when in normal mode.

R3 Press to turn on / off the flame effect when in daily or weekly timer mode.



After Day / Time set

Flame Effect

R4 Press to enter the flame effect adjustment screen.

R5 Press the '←' and '→' button to select the 3 kinds of flame effect

R6 Press the '+' and '-' button to select the 5 brightness settings of flame effect and the OFF setting

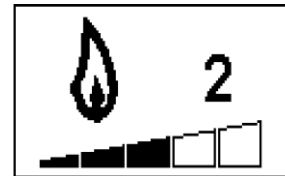

Normal Mode

R7 Normal control mode is factory set. If it is not then press the **M** button until the logo **N** is shown in the upper right corner of the screen.

R8 Press the '+' and '-' button to adjust the temperature setting from 17°C to 25°C in 2 degree intervals

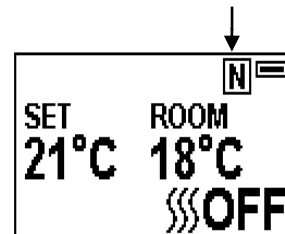

R9 Press **A** button to turn on / off the heat ON
OFF will show in the lower of the screen

NOTE: It is normal for the heater to stop running for periods of time. This happens because the room temperature is at or above the temperature set on the remote control.

The heater running indicator will be turned off after 10s if you have the flame effect turned ON. The heater running indicator will stay ON if you use the heating function only without the flame effect.

Count Down Timer

NOTE: This setting can only be used in normal mode. It allows the appliance to go into standby after a set period of time.

Press  to cycle through the settings from Off, 0.5 hours to 9 hours. The timer logo and time will show on the screen. **The heater must be in the ON position.**

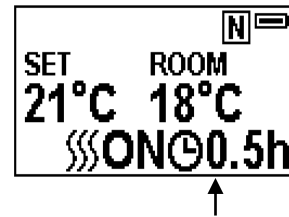

The heater can be automatically run by using daily timer and weekly timer on the remote.

Set up Day, Time and Comfortable temperature.

R11 Press  to turn on the remote handset. Hold button **M** for 3 seconds to enter the setting screen

R12 Press the '←' and '→' button to choose Day, Time or your comfortable temperature. The character selected will be highlighted.

R13 Pressing the '+' and '-' button will adjust the number.

- Time: 24-hour system
- Select your comfortable temperature from 15-25°C.
- Temperature unit: °C / °F

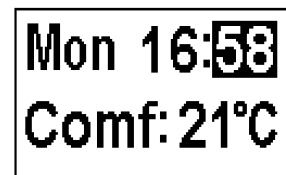



Daily Timer Heating

R14 The following are the pre-set heating periods, these can be altered if required

06:00 until 8:30
17:00 until 22:00

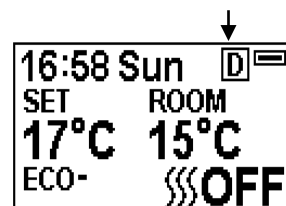
R15 Press **M** until **D** is shown at the upper right corner of the screen then enter the daily timer heating



R16 Hold the arrow symbol button  for **6 seconds** to enter the daily timer setting. Max of 3 timed heating periods per day.

Press '←' or '→' to choose hour or minute, press '+' or '-' to set the time.

The minute will increase / decrease by 15 minutes per press. Hold  for 3 seconds or wait for 10 seconds to save and exit the heating time period setting.

| Day Timer Setting | |
|-------------------|----------|
| 06:00 | -- 08:30 |
| 17:00 | -- 22:00 |
| 00:00 | -- 00:00 |

R17 Adjusting the set temperature

Press the '+' or '-' button to increase or decrease the temperature on the basis of your comfortable temperature setting

ECO means 2°C lower than you're comfortable temperature setting

ECO- means 4°C lower

COMF+ means 2°C higher

COMF++ means 4°C higher

R18 To check your daily timer settings press 

R19 If heating needs to be turned off, it will be necessary to go back to the Normal Mode to turn off.

Week Timer Heating

R20 The following are pre-set heating periods, these can be altered if required.

From Monday to Friday

06:00 until 08:30

17:00 until 22:00

From Saturday to Sunday

06:30 until 9:30

11:00 until 13:00

17:00 until 22:00

R21 Press **M** until **W** is shown at the upper right corner of the screen then enter the week timer heating mode.

R22 Hold **←** button for **6 seconds** to enter the weekly timer setting

Press '**←**' or '**→**' to move the cursor (a flashing underline), press the **←** button in the corresponding week position to select (the character is highlighted) or cancel (the character is displayed normally) the current setting. Several days can be selected together.

Press the '**→**' button to move the cursor to the time period setting area. Press '**←**' or '**→**' to choose hour or minute, press '**+**' or '**-**' to set the number.

Max of 3 heating periods per day. The minute will increase / decrease by 15 minutes per press.

Press the **←** to set the heating time for the selected day(s) and return to the week line.

Hold **←** for 3s or wait for 10s to save and exit the heating time period setting.

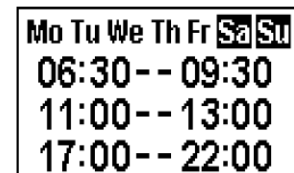
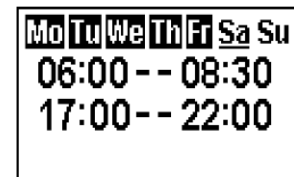
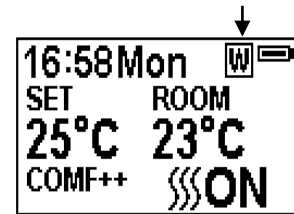

R23 Press **←**, '**←**' and '**→**' to check your week timer settings.

R24 If heating needs to be turned off, it will be necessary to go back to the Normal Control Mode to turn off.

Advance Mode

R25 Under the daily and week timer mode, press **||| A** to turn the heater off when the heater is on during a pre-set heating period.

Or turn the heater on when the heater is off in between pre-set heating periods.

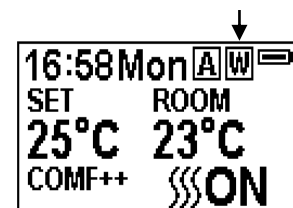

Adaptive Start Control

R26 According to room temperature and set temperature, the heater will automatically come on in time to heat the room to the set temperature at the set time. For example, if your timer is set to start at 18:00 and temperature is set to 23°C, the fire will come on at 17:30 to ensure the room is 23°C at 18:00.

Window Open Detection

R27 When the transmitter detects a rapid drop in room temperature, it will be judged as a window open, the warning icon will be displayed and the heating will be turned off automatically.

R28 After the indoor temperature has risen or a manual override of the warning (by operating remote control) has been done, the fire will return to normal working state.



Set up the communication between the remote and the appliance

R29 The following operations should be carried out before programming, when changing to a new remote or in the event the appliance cannot be controlled by the remote:

- Hold the reset button on the appliance for 3 seconds (pen point may be needed) until you hear 3 short beeps from the unit, release the button. (See page 9 for button location)
- Press the  button on the remote, the programming is finished when you hear 1 long beep from the appliance

R30 Resetting the code for remote control is necessary if the appliance operates incorrectly or the remote control does not operate correctly.

- Open the back cover of the remote control.
- Press the Reset button on the remote control.
- Follow the steps R29



Resetting the Thermal Cut Out

R31 This appliance is fitted with an Electronic Safety Control (E.S.). This is a safety device, which switches off the fire if, for any reason, the appliance overheats, e.g. when covered. If the heater stops operating while the flame effect continues working normally, this indicates that the E.S. Control is in operation. The E.S. Control can only be re-set after the appliance has cooled down, and the appliance has been reset. Re-setting of the E.S. Control proceeds as follows:

R32 Switch off the appliance (Manual On / Off switch) and leave it off for approximately 10-15 minutes.

R33 Remove any obstruction to the fan heater outlet or fan blades etc. Make sure that the power supply is disconnected with the plug socket outlet while doing this.



R34 Switch on the appliance and the E.S. Control will be re-set.

R35 Ensure that the appliance is functioning correctly. If the E.S. Control operates again, the appliance should be checked by a competent electrician.

WARNING: Before undertaking any maintenance or cleaning disconnect your appliance from mains supply and ensure it is completely cool.

Only competent persons should service / repair this appliance.

Remote Handset Battery Replacement

- When the batteries are at full power, the battery symbol will show 
- When the batteries are half full, the battery symbol will show 
- When the batteries are out of power and need replacing immediately, the battery symbol will show 
- Battery replacement is recommended after 1 year. The batteries are 1.5V alkaline AAA, batteries.
- Dispose of old batteries at an appropriate recycling facility.
- It may be necessary to set up the communication between the remote and the appliance after the batteries have been replaced. See R29.

Maintenance:

WARNING: - Before undertaking any maintenance or cleaning, ensure appliance is disconnected from mains supply. Only competent persons should service / repair appliance.

WARNING: There are no internal user serviceable parts, i.e. bulbs, in this product. Under no circumstance should access be gained to the internal parts other than by a suitably qualified person.

Please note: - If the supply cord on this appliance is damaged it must be replaced by the manufacturer, Authorised Service Agent, or a qualified person to avoid hazard.

General Suite Care – not glass

To maintain the appearance of your new suite we recommend that it is dusted using a lint free cloth. NEVER use any form of abrasives or a DAMP cloth on the surround.

The area around the fire should be kept free of any materials such as lint or house dust (i.e. animal hair / carpet fibres) that could be drawn into the internal workings of the appliance and hence affect the performance. We recommend that you clean around the fan grille housing at regular intervals. This can be done using standard vacuum cleaner and suitable attachment.

Glass Care

Periodically it may be necessary to remove the glass screen for cleaning, this is achieved by first disconnecting the appliance from the mains supply, then remove the brackets in the top left and right hand corner of the glass screen by unscrewing the 4 screws (2 per side) whilst supporting the glass from the front. With the brackets removed, lift the glass panel upwards and towards to remove the panel from the fire, place in a clean, soft, safe location for cleaning. When cleaning the glass panel use a slightly damp cloth. **DO NOT** use washing powders or any other substance containing abrasives as these substances can scratch the glass. Refitting the glass is the reversal of the removal procedure.

Electric Fire Guarantee

Be Modern Group (the 'Company') provide a **twelve month** guarantee in respect of electric fire (the 'Product') ranges.

1. The twelve month Guarantee applies to:

- All 'Products' in the ranges manufactured by the 'Company' (but subject to exceptions below); where
- The 'Product' has been purchased and installed within the UK and in respect of
- The initial installation; and in favour of
- The original Purchaser

2. Proof of purchase must be retained by the Purchaser

3. The twelve month Guarantee does not apply to:

- Damage or inferior workmanship practices while the 'Product' is being installed
- Damage caused by the mis-use of the 'Product' or where normal standards of care and use have not been complied with.
- Damage through a malfunction or an inadequately installed electric fire.
- Damage or defects due to, mis-use, accident or unauthorised alterations.
- During the **twelve month** after the 'Product' has been supplied, the Guarantee covers the making good (whether by repair or replacement at the company's option) of defects arising from defective manufacture of materials of 'Product' covered in paragraph (1), all at no cost to the Purchaser.

This Guarantee does not affect your statutory rights

On requiring service contact the retailer who supplied your product who will assist you and advise you as necessary.

| Control PCB | Remote Control Receiver | Remote Control Transmitter |
|------------------------------------------|-------------------------|--------------------------------------------------------------------------------------------------------------------------|
| Hardware: RC01-041B01 Software: VI | Hardware: RF290B V1.2 | Frequency: ASK/OOK 433.92MHZ Maximum transmit power: 10mW Hardware:RF290A-TX-V1.3 Software: RF290A_C_V0.6.0.hex |

Be Modern Group Customer Services

Tel: (0191) 430 0901 Fax: (0191) 430 9522

General Information

Environment

Meaning of crossed –out wheeled dustbin:



Electrical appliances should not be disposed as unsorted municipal waste. Separate collection facilities should be used in the disposal of electrical appliances. Contact your local government for the information about the available collection systems. If electrical appliances are disposed of in landfills or dumps, hazardous substances can leak into the groundwater and get into the food chain, damaging your health and well-being. When old appliances are replaced by the new ones, it is a legal obligation for the retailer to take back the old appliance for disposals at least free of charge.

This fire complies with the Safety Standards EN 60335-1 and EN 60335-2-30 which covers the essential requirements of the Low Voltage Directive 2014/35/EU and the EMC standards EN 55014-1; EN 55014-2; EN 61000-3-2 and EN 61000-3-3 which covers the essential requirements of the European Electro Magnetic Compatibility 2014/30/EU, and the RED standards EN300220-2, EN301489-1, EN301489-3 and EN6247 which covers the essential requirements of the European Radio Equipment Directive 2014/53/EU.



This fire complies with the Safety Standards BS 60335-1 and BS 60335-2-30 which covers the essential requirements of the Electrical Equipment (Safety) Regulations 2016 and the EMC standards BS 55014-1; BS 55014-2; BS 61000-3-2 and BS 61000-3-3 which covers the essential requirements of the Electro Magnetic Compatibility Regulations 2016, and the RED standards BS 300220-2, BS 301489-1, BS 301489-3 and BS 6247 which covers the essential requirements of the Radio Equipment Regulations 2017.



RoHS stands for Restriction of Hazardous Substances, and impacts the entire electronics industry and many electrical products as well. The Restrictions of the Use of Certain Hazardous Substances in Electrical and Electronic Equipment Regulations 2012, originated in the European Union in 2002 and restricts the use of six hazardous materials found in electrical and electronic products. All applicable products in the EU and UK market since July 1, 2006 must pass RoHS compliance.

