

# BROSELEY

## **Installation & Operating Instructions For Gas Q5 Stoves**

**IGNITE 5 GAS STOVE – (CD1) MK2  
HEREFORD 5 GAS STOVE – (CD2) MK2  
DESIRE 5 GAS STOVE – (SD1) MK2**

**Remote or Manual Control  
Conventional, Top or Rear Flue, Natural Gas Stove**

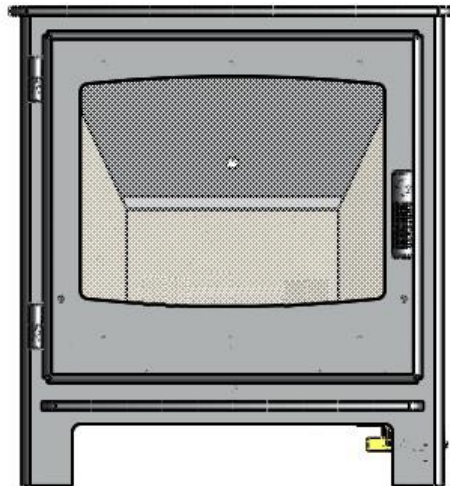

**IT IS A REGULATION THAT THESE INSTRUCTIONS ARE HANDED TO THE CUSTOMER AFTER THE INSTALLATION IS COMPLETE. IT IS ALSO THE RESPONSIBILITY OF THE INSTALLATION ENGINEER TO ENSURE THE CUSTOMER IS ABLE TO FULLY OPERATE THE APPLIANCE AND IS AWARE OF ANY CLEANING OR MAINTENANCE REQUIREMENTS.**

**Please note: Gas installations MUST only be carried out by installers who are Gas Safe registered.**

**Warning - Appliance should not be used if the glass in the door is cracked, damaged or broken.**

**This product is not suitable for primary heating purposes.**

## Contents

Introduction	3
Packing List	3
Specification	4
Dimensions	4
Hearth Requirements	5
Chimney Requirements	6
<b>Assembly</b>	
Burner Installation	7
Mica Board Installation	8
Fitting the Decorative Log Retainer	9
Connecting the TTB Sensor Manual Operated Stove	9
Connecting the TTB Sensor Remote Control Operated Stove	10
Positioning the logs	11 - 18
Gas Connection & Pressure Testing	19
Spillage Testing	20
Maintenance	21
Operating the Stove Manual Control Version	22
Operating the Stove Remote Control Version with Display	23 - 31
Cleaning the Stove / Curing the Paint	32
Trouble-shooting / Servicing	33 - 34
Commissioning Form	35
Guarantee	36
Energy Efficiency Rating	37 - 38

## Introduction

### THANK YOU FOR PURCHASING A BROSELEY GAS STOVE

Broseley Fires Ltd, a family run company, was founded as an appliance and design development company in 1975.

Since then we have built up an enviable reputation for the quality, reliability and fuel efficiency of our stoves.

These instructions have been carefully prepared to guide the installer and end-user through the relevant methods and standards for installation of your new Gas Stove.

Correctly installed and operated, your stove will give you many years of warmth and reliability. Therefore, we would suggest that you read the whole instruction manual prior to handing it to your installer. That way you will have a clearer picture of what is involved.

It is required by law that the complete assembly, installation and commissioning of gas stoves is carried out by a professionally qualified and accredited gas fitter listed on the “**Gas Safe**” register.

**THE INSTALLATION MUST BE IN ACCORDANCE WITH THE ‘GAS SAFETY INSTALLATION AND USE REGULATIONS’ IN CONJUNCTION WITH THESE INSTRUCTIONS AND THE RELEVANT ‘BRITISH STANDARDS CODES OF PRACTICE’ REQUIREMENTS AND THE RELEVANT ‘LOCAL AND NATIONAL BUILDING REGULATIONS’. A COMMISSIONING CERTIFICATE MUST BE LEFT WITH THE END CUSTOMER UPON FINAL COMPLETION AND THE COMMISSIONING FORM COMPLETED IN THE BACK OF THESE INSTRUCTIONS.**

## Packing List

### Stove Box

- 1 x Stove Body (with burner and Mica boards fitted)
- 1 x Flue Spigot
- 3 x Flue Spigot Fixings
  
- 1 x Instruction Manual

### Fibre Box (Packed outside Stove)

- 1 x Main Ceramic Base
- 8 x Loose Logs
- (N.B. The two additional side logs are only used on the Q7 version and can be discarded)**
- Remote Control Version only**
- 1x Remote Handset and batteries



Q5 Ceramic Layout



Q7 Ceramic Layout

## Specification

Heat Input (Gross)	6.0kW
Gas Category	I <sub>2H</sub>
Supply Pressure	20 mbar
Gas Rate	0.557 m <sup>3</sup> /hr
Injector Size	7 x 0.73mm (Q5)
Flue diameter	125mm (5")
Country of destination	GB, IE
Efficiency Class	Class 1
Nominal Output	4.5kW
NOx	130 mg/kWh (GCV)

**Please note this product is designed to only use natural gas G20.**

## Dimensions

**Ignite CD1 Q5 - WEIGHT 61 Kg**  
**Hereford CD2 Q5 – WEIGHT 56 Kg**  
**Desire SD1 Q5 – WEIGHT 58 Kg**

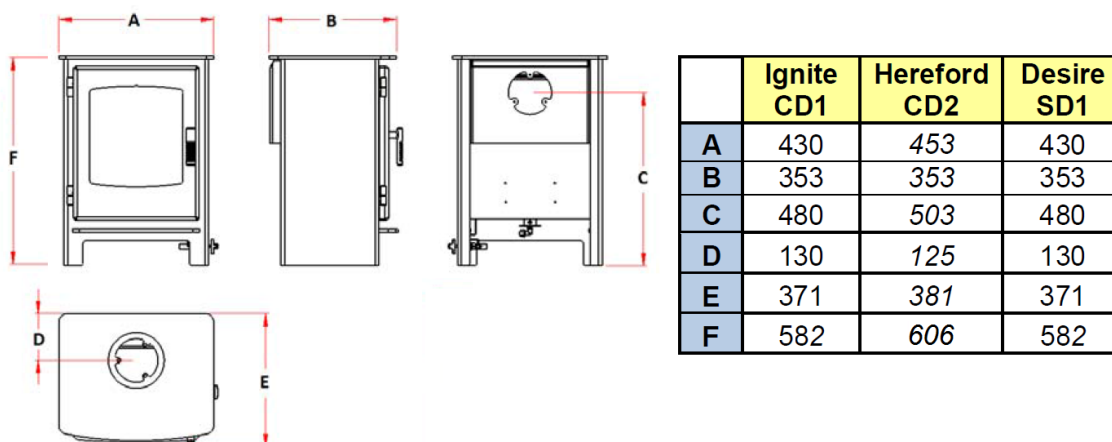

**All dimensions are in millimetres.**

All parts of this appliance become hot during normal use. All parts of the appliance should be considered 'working surfaces'.

## Chimney closure plates are not supplied

**The efficiency of this appliance has been tested to BS613 and a result of 83% NET (74.7% GROSS). This efficiency value has been verified by Kiwa (0558). This efficiency value can be used for SAP (Standard Assessment Procedure) for energy rating of UK dwellings.**

## Hearth Requirements

The appliance needs to be located onto a solid non-combustible hearth with a minimum thickness of 12mm. The hearth must be capable of withstanding the weight of the appliance.

**NB Side measurements taken from the Lid of the stove (Dimension E on page 4):  
Rear measurement taken from the dilution box**

Ensure all minimum clearances to combustible materials are complied with as below:

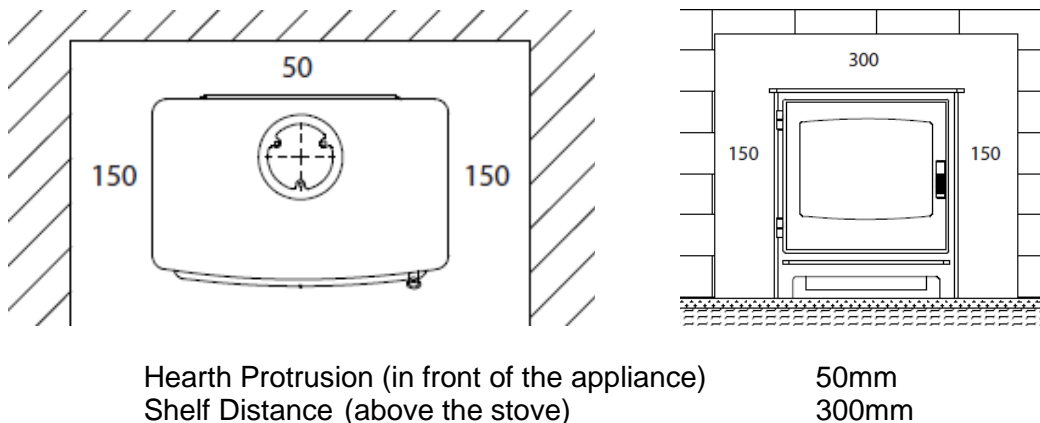

The specified minimum clearances provide the minimum distance to combustible and non-combustible materials. If the appliance is intended to be installed into a non-combustible opening, the clearances to the sides and above can be reduced. However it is recommended that the specific minimum clearances are maintained, irrespective of the materials used in the construction of the opening. This has been tested and approved to allow adequate air flow and access to the controls, as well as allowing access for smoke tests and future maintenance of the flue and the appliance.

**The clearance to the rear of the appliance must always be a minimum of 50mm. Clearances to combustible materials cannot be reduced**

**Please note the gas supply connection to the appliance is to the right hand side rear of the stove. The connection requires an 8mm-diameter semi-rigid pipe, not more than 1 meter in length.**

## Additional Requirements

- Curtains should not be positioned above the appliance at a distance of less than the minimum specified for shelves
- An additional guard is to be used to take account of the special hazards that exist in nurseries and other places where there are young children or aged or infirm persons present.

## **Chimney Requirements**

**Please note Broseley Fires do not provide flue pipes, closure plates or any other associated accessory.**

### **Top or Rear Flue Outlet**

The stove must be installed in accordance with current gas and buildings regulations BS5871: Part1. The appliance can be installed in any adequate area suitable for solid fuel fires and stoves. It can use a class 1, class 2 and pre-cast flue.

For pre-cast flue installations it is ESSENTIAL that a sealed connection is made into the actual flue system (a void behind a closure plate is not permitted). Please refer to the codes of best practice for further advice on pre-cast flues. Before you install the stove, make sure the chimney flue outlet is correctly positioned to align with the flue outlet on the stove and that the chimney is in good condition. If not, a chimney liner must be installed or a suitable class II gas flue used. A draught is necessary to ensure the products of combustion are fully evacuated.

**It is recommended that the flue run is as straight as possible. The flue must have a minimum vertical height of 3 metres to ensure adequate draught. You can have a maximum of four bends in the run, each bend must not exceed 45° and an additional metre of vertical flue should be provided for each bend. Ideally you should have a minimum vertical section of 600mm before any bend immediately off the top of the appliance, however it is permitted to use a 45° bend straight off the appliance provided you have an adequate flue draft.**

Prior to installation, the installer should ensure that the flue is free from obstruction and any dampers must be fixed in a permanently open position. Ensure the chimney is not closed and that it has been swept and subsequently smoke tested.

Make sure that rain, birds or any foreign body cannot get into the chimney to cause damage or blockage. This problem can normally be overcome by fitting an approved gas cowl. It is essential for the effective running of your stove that the chimney draws properly to allow the products of combustion to escape.

### **VENTILATION (GB ONLY)**

The gas stove is rated at less than 7kw and therefore does not normally require additional ventilation in the room (BS5871 – part II).

### **Flue Spigot Connection**

Attach the supplied 5" diameter spigot to the top or rear of the stove using the three M6x40 bolts and washers provided. The blanking plate (supplied) must be fitted over the remaining flue outlet using 3 off m6 Countersunk screws.

## Assembly - Burner Installation

The burner will come pre-fitted, however please ensure all components are present and fitted as per the information below to ensure nothing has moved (or become damaged) in transit. You will need a pozi drive screwdriver when fitting / replacing the gas burner.

- 1) Remove the stove body from its packaging and stand it in position.
- 2) To open the door, remove the handle by rotating it anti-clockwise until it clears the thread. The handle acts like a nut on a thread and once removed will allow the door to open fully.
- 3) Insert the burner end with the control knob first followed by the other end of the burner locating the burner bracket onto the side fixing points.
- 4) Fasten the burner into position using two (2) M6x40 bolts and washers provided



- 5) The stove base plate can now be fitted. This plate rests on left & right brackets.



- 6) Next fit the **2 x Ceramic rods** into the slots provided in the top burner brackets.



## Assembly – Mica Boards

As with the burner, the Mica boards will be pre-fitted into the stove. The information below will assist with the removal / re-installation should they need to be removed for maintenance purposes.

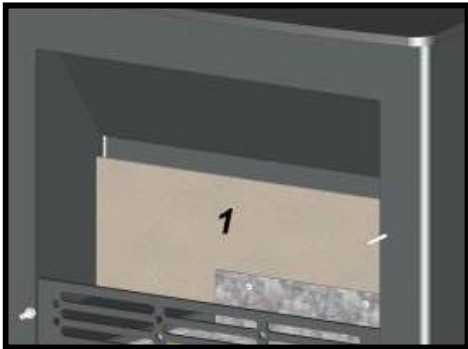

First fit the rear mica board as shown above.

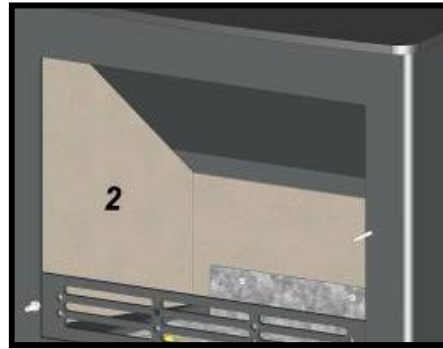

Now fit one of the side mica boards ensuring that the board is snug between the front of the stove and the rear mica

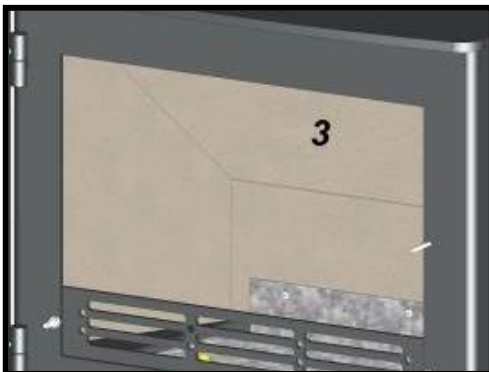

Next rest the top mica board onto the side board (this board will need supporting whilst the final side board is fitted).



Finally fit the reaming side mica board and allow the top board to rest down onto it (the top board should now be supported by both the side and rear mica boards)

**Please note you will also need to remove the pilot shield from the pilot before fitting the ceramics (this protects the pilot during transit).**



## Assembly – Decorative Log Retainer

Using the 2 off M5 C/Sunk Bolts provided, locate the decorative trim behind the stove opening as shown and secure in position.

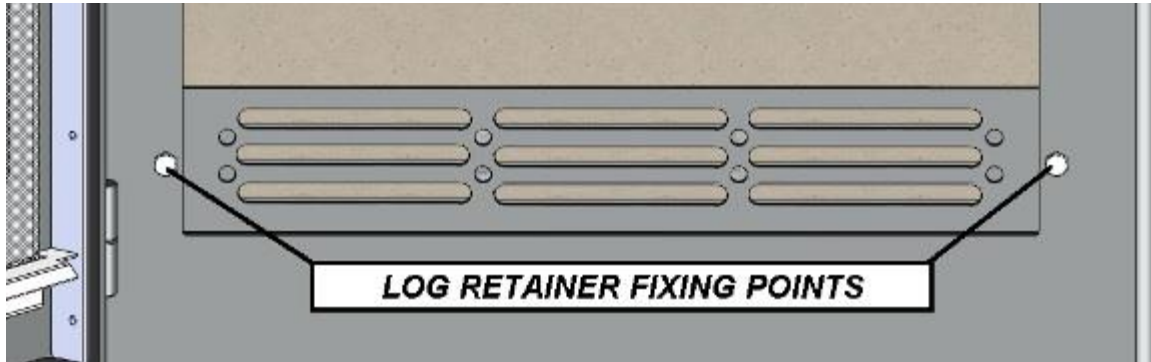

## Assembly - Fitting TTB sensor Manual Operated Stove

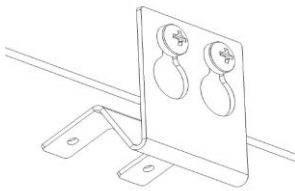

With the burner installed, thread the 2 x TTB wires from the pilot / thermocouple to the rear of the stove. Attach the two spade connections to the TTB which is fitted to the bracket shown in Fig 1. Attach the bracket to rear panel of the stove by inserting the keyhole cut-outs over the existing screw heads and drop down to final position. Tighten screws if required. Ensure the white fibre is between the stove and bracket.

Fig 1

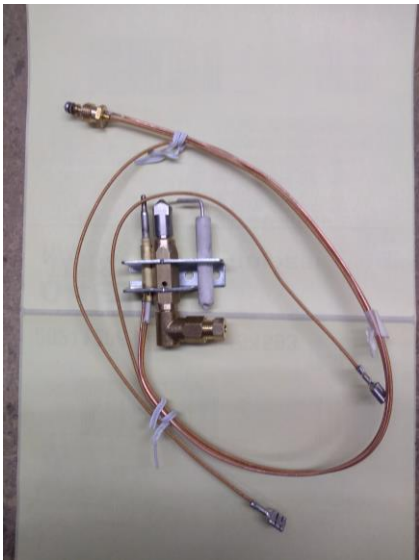

Pilot Assembly



Connection to gas valve



TTB Connections

## Assembly – Connecting the TTB Sensor Remote Controlled Stove

With the burner installed, thread the TTB connection cable through the rear of the stove and mount to the rear stove panel as below.

TTB

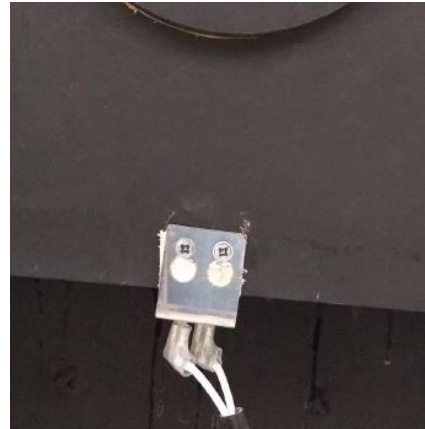

TTB fitted to rear of stove

Pilot and electrode connections

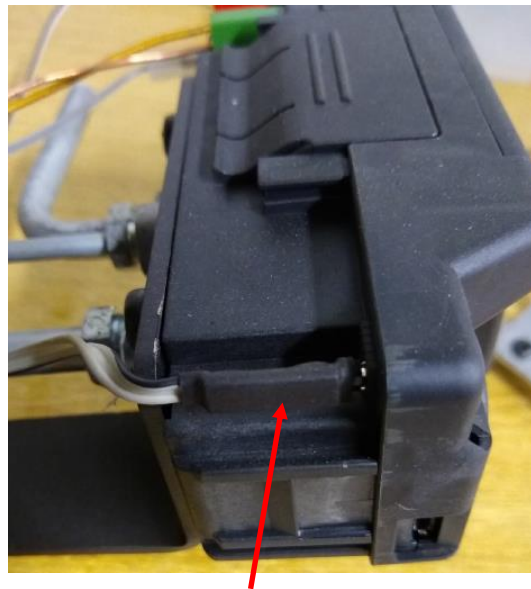
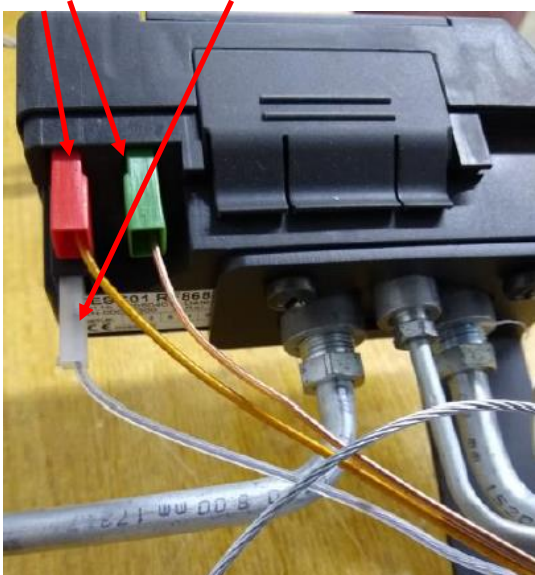

TTB wire into valve

**NOTE:-** Please ensure the TTB sensor is correctly seated down into the holder and not pushed up. If the TTB touches the bracket in anyway it could cause the sensor to short circuit and the valve will not work. It is also essential that the TTB wire into the valve is not disturbed or removed, if this wire is not making a good connection into the valve it will simulate an error and the valve will not operate with the handset showing an ERROR code. The power source should be disconnected prior to ANY servicing taking place. Never remove the TTB sensor or burner without disconnecting the power source to the valve.

## Assembly - Positioning the Logs

Only the ceramics supplied with this appliance should be used. The ceramics should only be laid as described. Before any ceramics are placed in position ensure that the pilot is not obstructed and the burner is operating correctly. Broseley Fires Ltd accepts no responsibility for any injury sustained whilst handling hot ceramics. Ceramics which are found to be placed other than in accordance with these instructions will result in a charge being made following any service callout. Replacement ceramics are available from your dealer.

We recommend lighting the burner for several minutes prior to positioning the ceramics. Once layout is complete, fire the burner and look for soot deposits. If soot is evident slight adjustments may need to be made to logs.

**NOTE:-** Ensure the two ceramic rods are in position prior to assembly of the ceramics, it is essential these rods are fitted to prevent soot build-up on both the burner and ceramics.

1: Place main base ceramic on top of the burner ensuring that it is located centrally left and right. The circle cut out at the front of the main fuel bed should be central to the pilot.

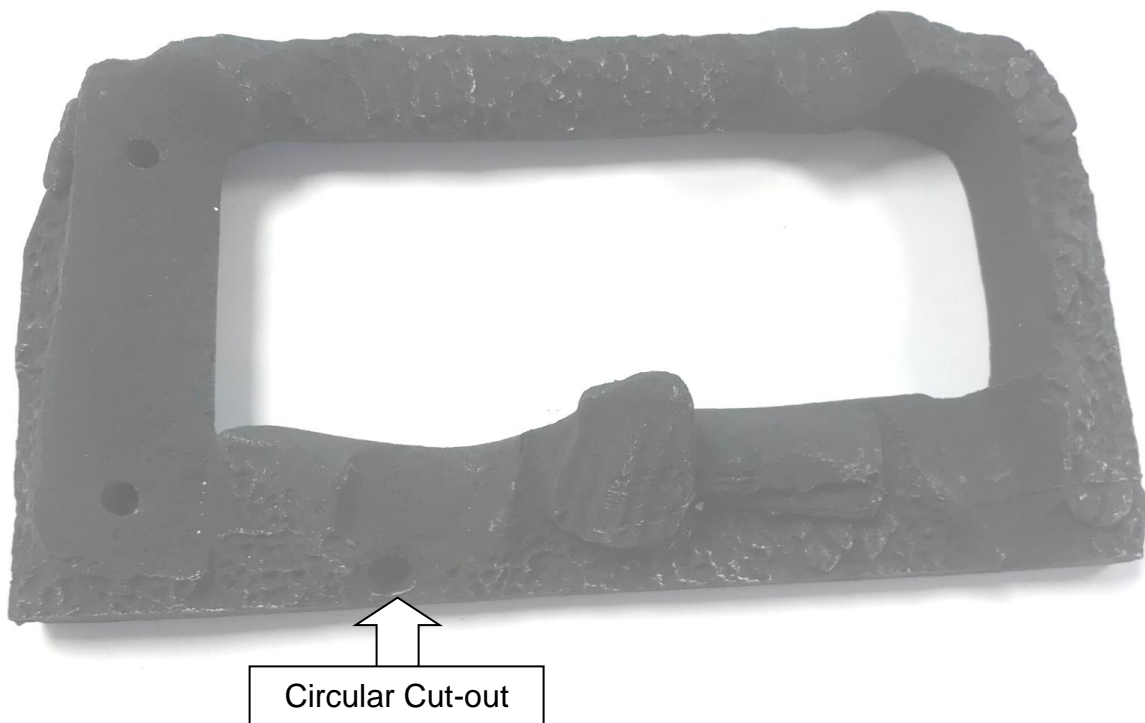

## Assembly - Positioning the Logs

2: Position the left as shown using the two pegging points, please note you should have a single peg pointing upwards at the back.



3: Do the same for the right hand side, again you should have a single peg pointing upwards at the back. Please note this lug simply rests into the recesses in the base rather than being pegged.

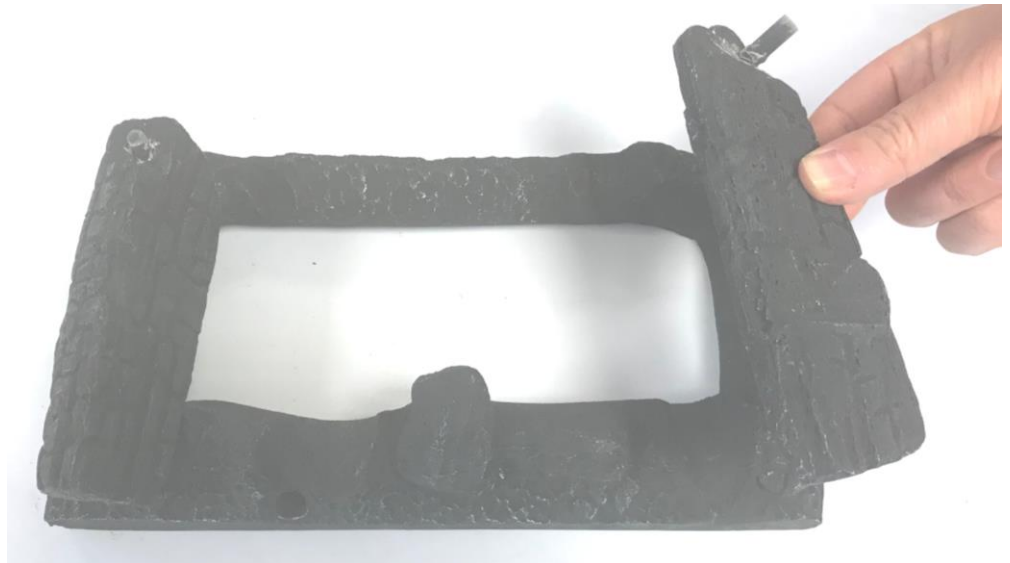

After steps 1-3 your log layout should look like this.





## Assembly - Positioning the Logs

4: Interlock the rear log into position as shown below



Position the rear log as shown with the thinner end to the right and the three holes facing you. This log locates onto the pegs at the back on the left and right hand pieces from steps 2 and 3).



After step 4 your log layout should look like this.

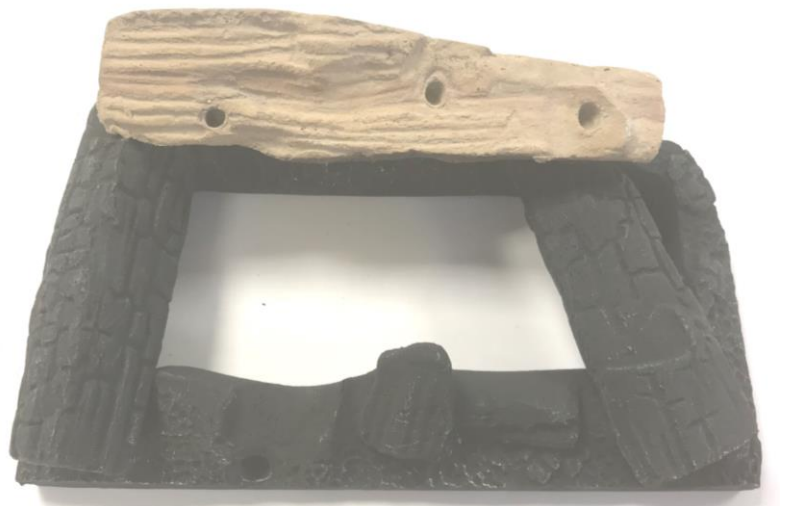

## Assembly - Positioning the Logs

5: Position the central log as shown. This log has a peg which locates into the central hole in the rear log.



After step 5 your log layout should look like this.



## Assembly - Positioning the Logs

6: Position the next log as shown so that it locates onto the peg of the central log.



After step 6 your log layout should look like this.





## Assembly - Positioning the Logs

7: The next ceramic locates into the right hole in the rear ceramic as shown.



After step 7 your log layout should look like this.



## Assembly - Positioning the Logs

8: This ceramic locates into the left hole in the rear ceramic.

You should have a peg pointing up at the front now.



After step 8 your log layout should look like this.



## Assembly - Positioning the Logs

9: Finally position the small front log onto the last remaining peg as shown.



Your log layout is now complete and should look like this.

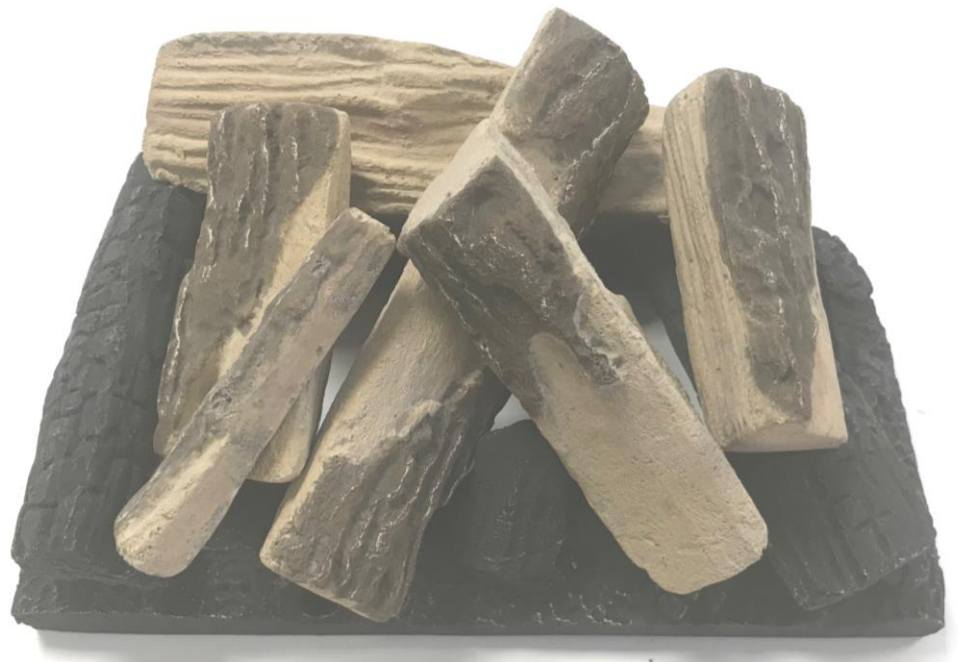

**Please note you will have two additional ceramic logs left over that do not have fixing points or pegs, these logs are used on the Q7 version and should be discarded.**

## **Assembly - Gas Connection & Pressure Testing**

A minimum 15mm-diameter gas supply pipe must be used to within 1 metre of the installation with the final connection to the stove to be completed with the suitable 8mm semi-rigid gas pipe. The 8mm pipe should be connected to the inlet of the gas valve using the nut and 8mm olive provided. Support the control whilst finally tightening the supply pipe.

The gas supply connection to the appliance is located at the right hand side rear of the stove. This connection is a compression fitting, sealant should never be used (as this can potentially cause a blockage).

### **Pressure Testing**

Always make sure that there is adequate gas pressure and volume to the stove. The relevant pressures are on the ID plate on the gas control knob.

1. **For natural gas, this is 20mbar** measured at the inlet connection to the stove with the appliance in the full rate position.
2. Ensure that the gas pressure to the stove is maintained when it is operating at the same time as other appliances in the building and that a suitable pressure gauge is used i.e. a manometer. **Any service call as a result of incorrect gas pressure will be chargeable.**

### **Ventilation (GB only)**

The gas stove is rated at less than 7kw and therefore does not normally require additional ventilation in the room (BS5871 – part II).

## **Spillage Testing**

A Spillage Test **MUST** be carried out before the installed fire is left with the customer.

Carry out the test by first closing all doors and windows in the room containing the fire. Ensure that the fire is burning at full rate for a minimum of 10-15 minutes.

**Using a lighted smoke match insert the head of the match into the draught diverter on the rear of the stove, observing the smoke being drawn into the dilution box, after 10 minutes repeat the test.**

If there is an extractor fan in a nearby room the spillage test must be repeated with the fan running and all connecting doors between the fire and fan left open.

If there are problems, the chimney / flue may require attention, see “Chimney Requirements” section.

### **Spillage Monitoring System**

This appliance is fitted with an atmospheric sensing spillage monitoring system, and an oxygen depletion-sensing pilot. These are designed to shut down the fire within a safe period of time if there is an excessive build-up of products of combustion within the room / dilution tunnel. This would usually only occur if the flue path suffered severe blockage and / or ventilation was severely impeded.

### **THE FOLLOWING ARE IMPORTANT WARNINGS RELATIVE TO THE SPILLAGE MONITORING SYSTEM**

1. The installer must not attempt any adjustments to the spillage monitoring system.
2. There must be no attempt to disable the spillage monitoring system.
3. It is not possible to replace individual parts of the pilot assembly on the appliance – only a complete pilot assembly (including thermocouple) may be fitted in the event of a replacement being necessary. When the spillage monitoring system is replaced, only complete and original manufactures’ parts may be fitted.
4. Should the appliance turn itself off, wait for a minimum of 3 minutes before attempting to re-light. In the event of your stove tripping out, consult your installation engineer to have the flue / chimney checked.

## Maintenance

### Door adjustment

In the case of the door rope not providing an adequate seal to the room, products of combustion may enter the room (see warning notes), to ensure an adequate seal the door may need to be periodically adjusted as the rope seal wears with use.

#### **Hinge Adjustment (seal on Left hand side is not compressed): DESIRE (SD1) AND IGNITE (CD1) MODELS ONLY**

- Ensure that the stove is cold before proceeding
- Remove the door by lifting the door off the hinges
- Loosen the Hinge Locking nut inside the stove
- Rotate the hinge by 1 turn (clockwise to tighten seal, anticlockwise to loosen seal) on both the top and bottom hinge, this ensures that the door seal will compress or loosen evenly
- Re fit the door back onto the hinges and tighten the locking nut inside the stove
- Check the seal provides an adequate seal.



## **Operating the Stove - Manual Control Version**

**It is important to read these instructions thoroughly before lighting the stove.**

The gas stove operates with a traditional permanent pilot light.

The knob for ignition and power control are located on the lower right hand side of the stove, the indicator in the plate shows the knob position (Marked on knob)

The pilot light is located at the front left corner of the front log matrixes.

If the Flame Supervision Device (the pilot light) is extinguished by intention or not, no attempt should be made to re-light **until 3 minutes have elapsed.**

### **IGNITING THE PILOT AND USING THE HIGH / LOW FUNCTION**

1. From the start position, depress the control knob fully.
2. Whilst depressed, turn knob sharply 90 degrees anti-clockwise to "pilot" setting. You should feel some resistance and hear a click. Repeat until pilot light is visibly lit.
3. **Keep knob depressed at this point for 15-20 seconds, then release.**
4. Upon releasing, ensure the pilot is still lit, if not, repeat above steps.
5. With the pilot established, turn the knob Anti-clockwise to select the low flame setting. Turning the control further anti-clockwise you will be able to select the high flame setting.
6. From the high setting you can select low by turning the control knob clockwise.

### **EXTINGUISHING THE STOVE FULLY**

1. From any heat setting, or the permanent pilot, depress control knob and turn clockwise to "OFF" position.

In adverse conditions and when the flue is extremely cold it is possible the products of combustion may build up inside the stove and not exit via the flue ways correctly, in this scenario the ODS will activate and turn off the burner. If this occurs try to light the burner again, this could take several attempts in order to get sufficient heat / draw in the flue so the products of combustion can leave the stove correctly.



## Operating the Stove - Remote Control Version

### Quick start user instructions

This control is situated on the lower right hand side of your fire. The drawing below shows the main features of the control.

The control requires 3 AA size alkaline batteries to be inserted under the battery compartment cover. The orientation of these is shown moulded into the battery compartment.

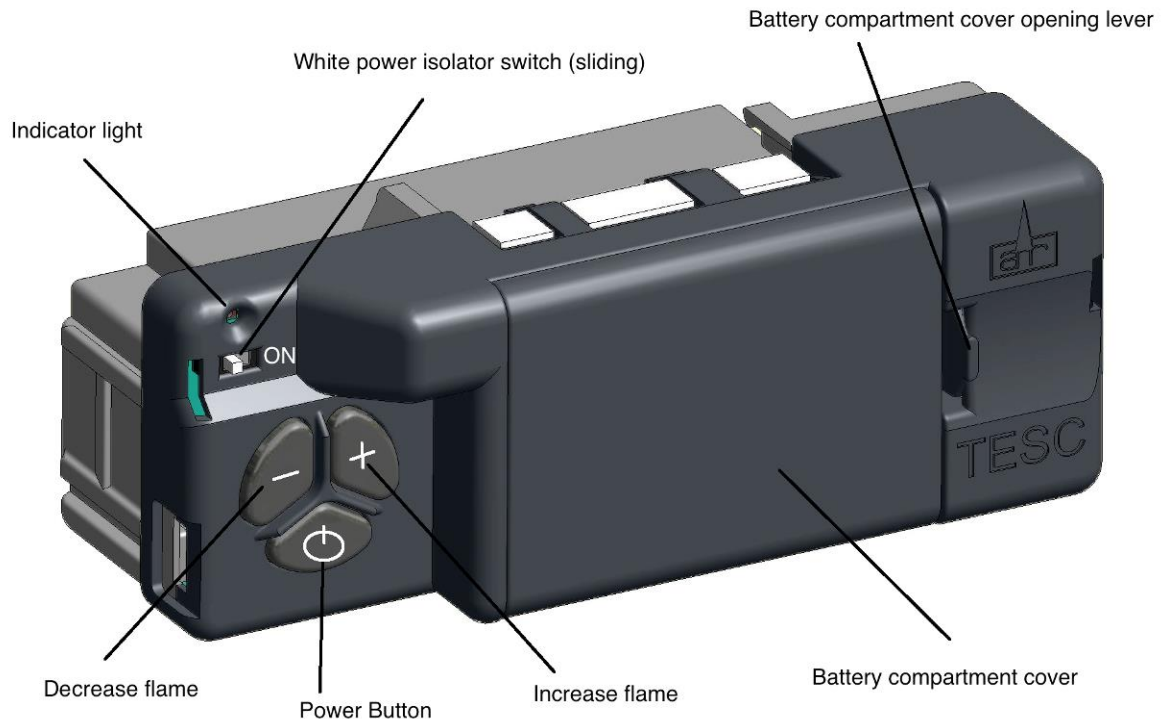

The power of the burner can be adjusted up and down by pressing the – and + buttons. After fitting the batteries and replacing the cover the fire can now operate. Slide the power isolator switch to the right to the on / I position.

To start the fire, press the power button and hold for 1 second then release. The burner will within around 1 to **10** seconds, adjust to the maximum power setting,

To stop the fire, simply press the power button again and the burner will stop.

If you are not intending to use the fire for a long period (i.e. over summer time months) the battery life can be extended even more by sliding the isolator switch to the left (away from the “on” / “I” position, **symbol 0**).

## Operating the Stove - Remote Control Version

### Handset

Ensure the power isolator switch on the front corner of Fire Control is in the on position I.  
NOTE: For safety reasons a button must be pressed and released for the command to be recognized. Keeping hold of a button when pressing (unless otherwise instructed) will not be recognized as a command press.

Grasp around the handset to unlock its functions. The green unlock light will illuminate to show when the handset is unlocked and ready to accept commands. (N.B. Keep a grip of handset to keep it unlocked, to continue to operate the command buttons)

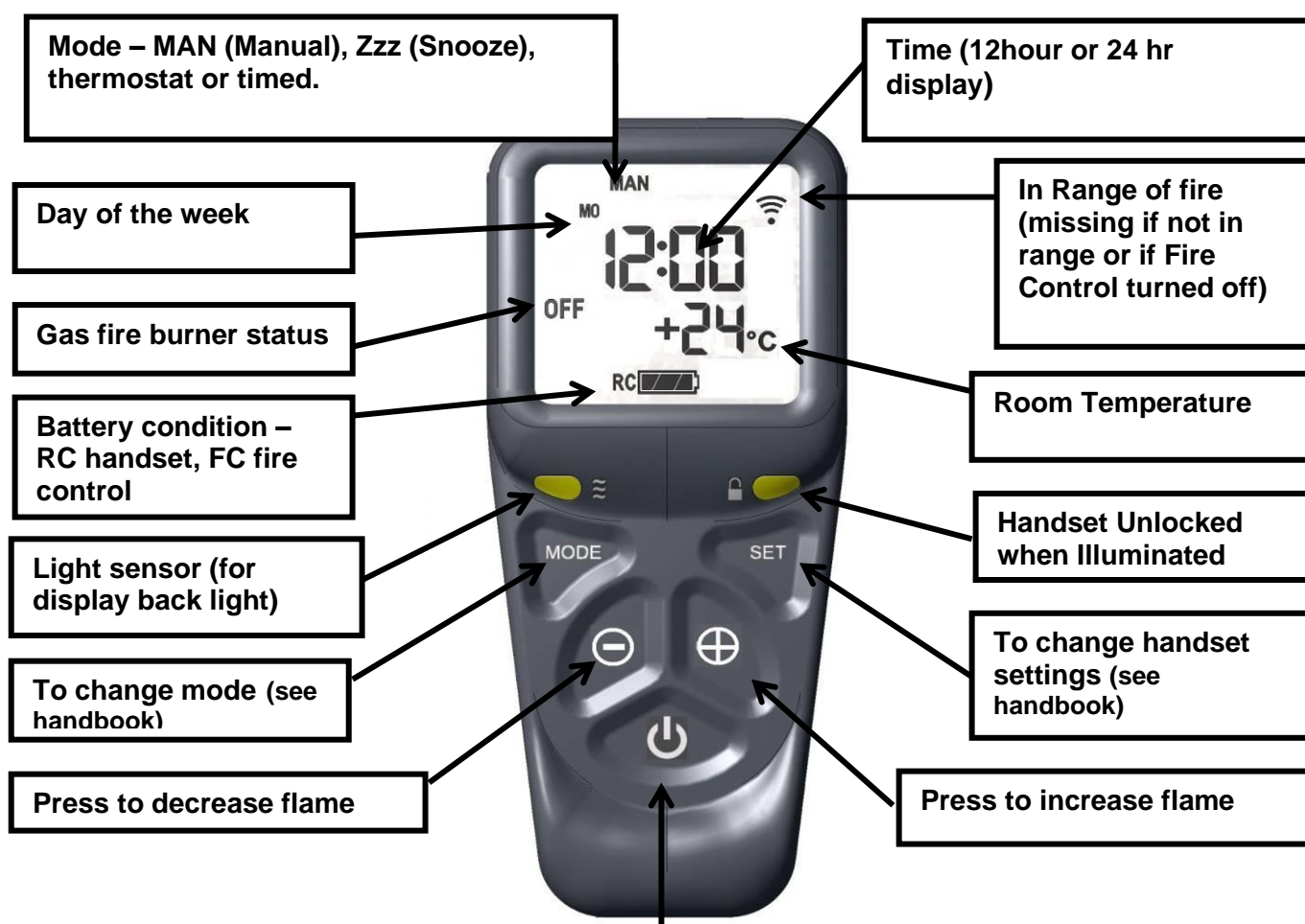

Power button - To start the fire (after following the instructions of the previous page) with one hand grasp around the rear of both sides of the button area control. The green unlock light will illuminate. Keep the handset held to keep the control unlocked, to enable operation of the buttons. Then with the other hand touch and hold a finger on the power button for about 3 seconds. (A short beep and a flash of the unlock light will happen upon touching.) When the word "pilot" appears at the bottom left hand corner of the display, immediately release the power button. (A second flash of the unlock light and a longer beep will also sound at the time to release the power button). The Fire should be lit within a few seconds. (N.B If power button is held for more than a few seconds after second flash/beep/word pilot appears; the command is ignored for safety reasons. Similarly if it is released too soon before the word pilot appears, the command is also ignored. With this system, the control has been designed to ensure that only intended ignition of the fire occurs.) To stop - with handset held to unlock it, press then release power button.

The handset comes already paired to work with the fire and the time set etc. Please read these instructions carefully and watch the instructional YouTube video through your internet web browser if necessary. Do not try pairing the handset thinking that it is not paired it is more likely the handset is not being pressed correctly.

For safety reasons the handset is made not to be operated by accident, please follow the instructions as below:-

- **The handset should be showing a Wi-Fi symbol  in the top right of the display. This means the handset is within range of the fire Control. (If the symbol is not there check a) the batteries are in the handset and the fire gas control properly the correct way around, b) the batteries are good batteries and c) that the small isolation switch on the gas control in the top left corner is in the “ I “ position and not the “ O “ position).**
- **To start the fire, with one hand grasp firmly around the rear of both sides of the button area control. The green unlock light will illuminate. (Keep the handset held to keep the control unlocked, i.e. the green light on, at all times to enable operation of the buttons).**
- **Then with the other hand touch and hold a finger on the power button for about 3 seconds. (Upon touching a short beep and a flash of the unlock light will happen).**
- **As the handset beeps and flashes the green light for the second time, the word “pilot” will appear at the bottom left of the display, immediately release the power button as the word the word “pilot” appears. (It may take a few practices to do this correctly, but as stated it is done in the interest of safety to prevent unintended operation.)**
- **The Fire should be lit within a few seconds. (N.B. If power button is held for more than a few seconds after second flash/beep/word pilot appears, the command is ignored for safety reasons. Similarly if it is released too soon before the word pilot appears, the command is also ignored. With this system, the control has been designed to ensure that only intended ignition of the fire occurs.)To stop – with handset held to unlock it first, press then release power button.**

## Operating the Stove - Remote Control Version

### Setting the time

Should you have to set the time or change the time you need to enter the SETUP menu. Hold the handset to unlock the keypad and keep held throughout the following steps, (if you release too soon the menu will exit and you will have to start again). Press and hold set for several seconds. The symbol in the top centre will flash. Press and release the “mode” button several times until the word “SETUP” appears flashing in the top right corner of the display.

Press and release “set” again to enter the “SETUP” menu.

Here you can change the clock from 12 hr or 24 hour format, the day of the week, hour of the day, minute of the day and the display in Celsius or Fahrenheit.

**To navigate through the menu “set” moves to the next parameter and “Mode” moves back to the previous parameter. “+” and “-” change the display parameter.**

### Setting the display for 12 or 24 Hour display

The H indicates that it is time to set the timer to either 24 hour display or 12 Hour (AM or PM) display. Press the + or – button on the handset to toggle between the two settings. When you are ready to confirm the setting you want press the “SET” button to progress to setting the day of the week.

### Setting the day of the week

Press and release the + and – buttons until the correct day of the week is shown on the display.

(Mo = Monday, Tu= Tuesday, We=Wednesday, Th=Thursday, Fr=Friday, Sa= Saturday and Su=Sunday).

Press “SET” to accept the day of the week and to progress to setting the Hour of the day.

Note: Whilst doing this setup pressing “SET” advances to the next display and pressing “MODE” will return you to the previous display setting.

### Setting the Hour

Press and release the + or – button to change the hour to the correct hour and press set to store and to move to setting the minute. Repeat this for setting the minutes.



## Operating the Stove - Remote Control Version

### Setting the temperature display to Celsius or Fahrenheit

Press and release the + or - button to toggle between C and F. When the display shows the desired symbol, press and releases the "SET" button to store.

As the important settings above have now been done, press and hold for a few seconds the "SET" button for a few seconds and this will exit the setup menu. The control is now ready for use with the Fire Control.



### Paging the handset

If you have misplaced the handset you can page it by pressing the + button only on the fire control for around 5 seconds. The handset will flash and make a noise to help you to locate it. Once you pick up the TESC it knows you hold it and so the sound stops. The flashing and sound will last for 60 seconds each time the handset is paged as described. If not found in 60 seconds, page again and so on. NOTE: PRESS "+" Button ONLY, NOT "+" and "-" Together as you will accidentally break the handset pairing and have to reset handset to factory state and pair again (see other parts of the booklet if this happens). Note: the legend at the bottom shows the battery condition of both the batteries in the hand set and in the fire control alternately. RC = Remote Control handset and FC = Fire control. The control is designed to get the most out of the batteries but when eventually the display shows they are spent (when the battery legend is an empty area, we recommend you change the batteries in the handset before they are flat, to avoid having to re-program the time of day in again. N.B. Pairing is not lost, even if the batteries are removed or flat.

### Advanced settings Menu

In the event that you may want to change the other pre-set settings of the control features. Do not do a long press and hold above but a normal short press and release will take you into the advanced settings area.

Advanced settings options are:-

- Back light –
  - A = Automatic (default setting). The back light comes on in the dark but not in the light.
  - 0 = Light never comes on.
  - 1 = Light comes on whenever handset is unlocked.
- Display contrast – 8 levels from 0 to 7 (default level 4).
- P = pairing with other devices other than the fire control. The hand set can pair with other modules to :-
  - L= Operate an electric light – which is the dimmable in 9 steps
  - F= operate an electric fan –which can have 9 speed levels
  - A= operate an auxiliary contact to operate another device.

## Operating the Stove - Remote Control Version

### Other Modes than Manual mode

Depending upon the model of fire, your handset maybe enabled to have some automatic features, namely, Thermostat mode, timed thermostat mode and snooze mode. Snooze mode can be selected to work with in conjunction with either manual or thermostatic modes.

You can switch between modes at any time with the handset unlocked by pressing and releasing mode button to toggle between modes.

Note: If at any time the power button is pressed during operation, this will stop the fire and exit any automatic mode and return the handset to manual (MAN) operation mode.

### Pairing the Handset to the Fire Control and resetting the handset to accept new pairing

NOTE: Do not do this operation just because of difficulties in understanding of operating the handset. The control is supplied originally with the pairing done so should not need doing on initial installation. Check understanding of control operation is understood.

**If either the handset is reset or the gas control has the pairing operation buttons operated, the pairing that existed will be broken and both the two operations below will be required to be done to enable a new pairing to be set up.**

#### **Firstly Factory Reset of display handset** (to enable handset to be paired again)

- To reset a handset to factory conditions and enable it to be paired with a new control, hold the handset to unlock.
- Press and hold the “set” button until handset beeps and release the “set” button. The symbols at the top of the display will be flashing.
- Press and release the mode button as necessary until the word SETUP is flashing in the top right corner.
- Press and release the “set” button again to enter the “setup” menu.
- Press and release the “set” button several times until CAO appears on the display (CA means Cancel All).
- Press and release the “+” button once to change the display to CA1. Press and release the “set” button once more and the display will change to say the word TESC as shown adjacent.
- The handset is now free to pair again.



## Operating the Stove - Remote Control Version

### Pairing Gas control with handset after handset has been made free to pair as above operation:

- Ensure all the batteries are fitted correctly and with the power isolator slide switch on the TESC Fire control put in the "I" position).
- Place the handset within 1 metre (3 feet) of the fire when pairing Simultaneously press and hold the – and + buttons on the fire control (i.e. not the handset) until the RED LED light on the gas control starts to illuminate. Immediately as it does so, press the power button on the gas control and the handset makes a noise and the display shows a symbol like a number 7 back to back with a reverse number 7.
- Then within a minute hold the handset to unlock the keypad a green unlock light will illuminate when the handset has detected your hand. The green light must be illuminated in this way for any of the command buttons to accept commands to operate the fire control.
- While the display is as described and holding the handset as described, press the "SET" button with the other hand to accept the pairing request to finish off the pairing of the handset to the Fire Control and to enter the setup the time of day on the handset as described in previous sections.

**N.B** If the display returns to the one shown above with the word "TESC" shown, then too much time has passed before pressing "SET" and so the handset has not paired yet. Simply repeat pairing again. **N.B** Only ever press the "+" and the "-" buttons together when pairing handsets. If done afterwards this will break the pairing made and a factory reset of the handset will need to be performed See Factory Reset of display handset later on in the instructions.

### Snooze mode in manual operation

Snooze mode is a time period you can set which will turn off the fire after a certain time period has elapsed.

The snooze time period can be set before or during manual operation of the fire. Hold the handset to unlock as described previously and press the mode button as many times as necessary until the word MAN and the Zzz symbols are flashing at the top of the display. Press and release the set button and this will put the control into Manual snooze mode.

The default time period for the snooze time period is 1:00 hour. Pressing the set button again will show you the snooze time period remaining. This can be adjusted by pressing the "+" or "-" buttons. The timer period that can be set is from 1 minute to 4:00 hours.

After adjusting the time, press set again to enter the time setting required (or if left for a few seconds this time is now stored and used).

Once this countdown timer has reached zero the fire will turn off (as if you had pressed off manually, it does not recycle).



## **Operating the Stove - Remote Control Version**

Snooze mode in Thermostatic mode

The same thing as above can be done before or during a thermostatic mode operation (see below).

Thermostatic mode

The handset has within it a thermostat sensor and this can be set so the fire will heat the room to match the temperature set in the handset. There are 3 temperature types that can be set:-

- Day mode temperature that has a sun symbol on the display – the default temperature is 24 C

- Night temperature that has a half moon symbol on the display- the default temperature setting is 18 C

- Frost protection that has a snowflake symbol on the display – the default temperature setting is 5 C

Hold the handset and press and release the mode button several times as necessary until the display has a thermometer symbol flashing at the top of the display. Press the set button to enter this mode. Press the set button again to see the temperature setting that is set and the mode (the default is 24 C) and on the left of the display is a sun symbol showing it's the day temperature. If a different set temperature is required, while the display is showing this set temperature, press the + and – buttons to alter the setting. When finished either press set or leave and after a few seconds the new setting will be accepted and the display will return to the time of day screen.

On the anniversary of the net minute of the clock, the set temperature will be compared to the actual temperature displayed on the handset (i.e. the room ambient temperature around the handset).

Note- when the set temperature is reached while the fire is in operation, the fire reduces the burner power level each minute until the burner is reduced to the minimum setting. Once the temperature in the room drops below the set temperature the burner power level will increase each minute until the burner is increased to the maximum setting.

Note: If at any time the power button is operated during Thermostat mode, the control will cancel any thermostat operation and return the control to manual mode.

## **Operating the Stove - Remote Control Version**

### **Paging the handset**

If you have misplaced the handset you can page it by pressing the + button only on the fire control for around 5 seconds. The handset will flash and make a noise to help you to locate it. Once you pick up the TESC it knows you hold it and so the sound stops. The flashing and sound will last for 60 seconds each time the handset is paged as described. If not found in 60 seconds, page again and so on. NOTE: PRESS “+” Button ONLY, NOT “+” and “-” Together as you will accidentally break the handset pairing and have to reset handset to factory state and pair again (see other parts of the booklet if this happens).

Installer note:

To reset the handset to factory conditions (to enable the handset to be paired with another fire for example), hold handset to unlock, press and hold for at least 10 second the SET button. The green and red lights will start to flash. They will flash for 1 minute and during this minute if you want to reset the handset, open the battery box and remove a battery for a few seconds. Replace the battery and cover, the handset will now be reset and ready to pair as a new handset to another (or the same) device as shown above in pairing section.

### **Pairing a new handset**

Remove the back panel and insert two AA Alkaline batteries in the direction shown by the symbols moulded into the compartment and replace the cover. Hold the handset with one hand ensuring your hand is wrapped around the back and that your hand is in contact with both sides of the handset. The green light of the “Unlock” symbol should light and flash. The flashing indicates that it is not paired with anything at the moment and is ready to be paired. Put the handset down within 1 metre of the Fire that you wish to pair the handset with. Press the + and – buttons on the Fire Control (i.e. not the + and – buttons on this handset) for around 6 seconds. The red light on the gas control will flash and then within 2 seconds press the power button on the fire control the handset should make a noise and the green “Unlock” light should be flashing even without holding the handset. The handset has received a pairing request and to accept this pick up the handset and hold as described above to keep the keypad unlocked and press and hold the “SET” button for 3 seconds. You will hear a beep and now the handset is paired to the fire control. The unlock green light will stay permanently lit when holding the handset Note: If the power button differently to the above i.e. pressed for too long or too short a time or the grip on the handset is not firm or released too soon, the Ignition will be interrupted and not complete. The reason for the remote control having this strict start sequence is for safety reason so that the starting operation of the fire will be most unlikely to be done other than intentionally by an adult. If not done correctly, wait a few seconds and try again.

**PLEASE EXPLAIN TO THE CUSTOMER THESE LIGHTING AND EXTINGUISHING PROCEDURES**

## **Cleaning the Stove / Curing the Paint**

### **Important Note:**

Should the glass door become broken or damaged in any way, turn your stove off and do not attempt to re-light it. Contact your dealer for a replacement to be fitted before relighting the appliance. The glass used in this appliance is a ceramic type glass suitable for operation up to 750 degrees do not use any other types of glass in this appliance.

### **Cleaning**

We recommend only doing this when the stove is cold using a soft brush to clean any of the stove surfaces, this is normally sufficient to remove dust and general debris. For stubborn marks you can use a damp lint free cloth, ensure that all surfaces are dried off immediately. We do not recommend using any kind of chemicals or abrasive materials. It is possible to touch up the paint using the original black stove paint, however this new paint will then need to cure.

### **Curing the paint**

It is important to note that upon initial lighting of the stove you will notice a strong odour, this is the paint curing and is completely normal.

Most high temperature paints operate in the same way. They use a resin which dries at room temperature and a silicon resin which cures at high temperatures. When the stove is burned the dry resin burns away and the silicon cures. This transition occurs about 240 degrees C / 475 degrees F.

Light the appliance and set the control to the "HIGH" position for the maximum output. The surfaces of the stove will take an hour to reach maximum paint curing temperature. The longer you can leave the stove at this temperature the faster the paint will cure (this could involve several prolonged periods)

### **IT IS NORMAL FOR THE STOVE TO GIVE OFF ODOURS WHILST THE PAINT, SEALANT AND METAL COMPONENTS.**

This product is free from asbestos.

This product uses components containing Refractory Ceramic Fibre (RCF), which are man-made vitreous silicate fibres. Excessive exposure to these materials may cause temporary irritation to eyes, skin and respiratory tract, consequently, it makes sense to take care when handling these articles to ensure that the release of dust is kept to a minimum. To ensure that the release of fibres from these RCF articles is kept to a minimum, during installation and servicing we recommend that you use a HEPA filtered vacuum to remove any dust and soot accumulated in and around the fire before and after working on the fire. When replacing these articles we recommend that the replaced items are not broken up, but are sealed within a heavy polythene bag, and clearly marked as RCF waste. RCF waste is classed as a stable, non-reactive hazardous waste and may be disposed at a landfill licensed to accept such waste. Protective clothing is not required when handling these articles, but we do recommend you follow the normal hygiene rules of not smoking, eating or drinking in the work area and always wash your hands before eating or drinking.

## Trouble-shooting

### The gas pilot will not ignite or stay lit

- Ensure the gas is turned on at the appliance and the meter.
- Check for blockages (especially after the pressure test point connection).
- Is there a strong spark being generated, if not firstly check that the spade connection is pushed fully into the pilot assembly. Check that the spark generator has not been bent in transit – if it has, bend the metal generator so the spark is hitting above the pilots gas outlet not below. The spark generator should be ideally 10mm from the pilot head
- The control knob must be held in for at least 20 seconds once the pilot is established to ensure the safety thermocouple is heated sufficiently.
- Ensure that both ends of the TTB connection cable are firmly connected and not damaged. If no damage, look at tightening the thermocouple connection to the splitter (see page 9). You will need an 8mm spanner for manual version. (See page 10 for remote version)
- Make sure that the brass interrupter (manual version) that connects the thermocouple and TTB to valve – shown on page 9) is not loose. You should not be able to move the interrupter by hand. Any break in the following circuit will cause the pilot not to stay alight as the electrical charge from the thermocouple needs to arrive at the valve to keep it open:

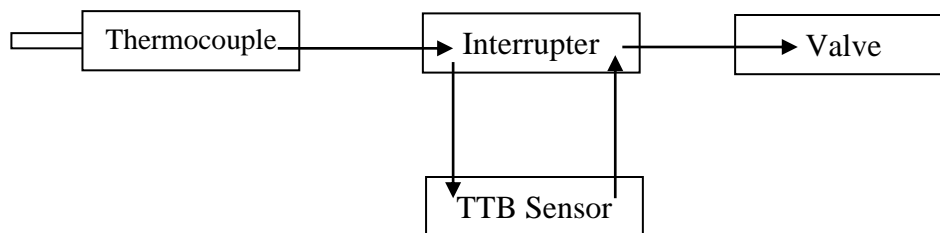

- Ensure that the pilot head, injector and burner ports are not obstructed or blocked and are free from any dust or dirt.
- Ensure gas pressures and flow rates are correct, as this will prevent ignition of the pilot. An indication of high pressure can be a whistling sound from the pilot.
- Ensure that the pilot assembly has not been damaged in transit. Be sure to check the gap between the thermocouple and electrode is sufficient and that the spark is not arcing elsewhere, this is a very delicate device.
- The pilot flame should burn with a strong blue flame. The flame should be focused on the tip of the thermocouple.

## **Trouble-shooting**

### **The main burner does not seem to burn correctly or will not stay alight**

- Check the flue draft. In adverse conditions and when the flue is extremely cold it is possible the products of combustion may build up inside the stove and not exit via the flue ways correctly, in this scenario the ODS will activate and turn off the burner. If this occurs try to light the burner again, this could take several attempts in order to get sufficient heat / draw in the flue so the products of combustion can leave the stove correctly.
- Ensure gas pressures and flow rates are correct.
- Test with all ceramics removed
- Confirm that the flame pattern is even across the surface of the burner by removing all of the ceramics. Only do this once pressures and flow rates are confirmed as being correct.
- Double check all ceramics are re-positioned correctly.
- Ensure that both ends of the TTB connection cable are firmly connected and not damaged. If no damage, look at tightening the thermocouple connection to the splitter (see page 9). You will need an 8mm spanner.

Once all the above checks are completed, leave the appliance in a fully commissioned state.

## **Servicing Instructions**

Servicing should be carried out annually by a qualified installation gas safe engineer.

- To open the door, remove the handle by rotating it anti-clockwise until it clears the thread. The handle acts like a nut on a thread and once removed will allow the door to open fully.
- Remove the logs and clean any dust and debris from the top of the burner unit and the inside of the stove. A vacuum cleaner can be used, but take care around the pilot assembly to prevent accidental damage. A clean soft brush can also be used. Take care not to brush any debris towards the pilot as this may cause an obstruction in the jet.
- Clean any dust/debris from each individual ceramic using a very soft brush.
- Check the condition of the ceramics. Damaged ceramics will affect the efficient operation of the stove and will need to be replaced.
- Clean the glass with a soft cloth.
- The outside of the stove can be cleaned as per instructions given previously.
- Re-lay the ceramics and close the door ensuring an air tight seal.
- Ignite the appliance and observe an even flame pattern.

Carry out all necessary final checks and leave the appliance in a fully commissioned state.

## Commissioning Form

**THIS SECTION MUST BE COMPLETED AND SIGNED BY THE INSTALLATION ENGINEER**

PLEASE LEAVE WITH THE CUSTOMER AND THE APPLIANCE.

Size of Governor setting: (i.e.) Natural Gas 20mbar.

Length and size of gas supply: \_\_\_\_\_

Meter pressure Fire only on: \_\_\_\_\_

Meter pressure with all other appliances on: \_\_\_\_\_

Burner pressure Fire only on: \_\_\_\_\_

Burner pressure with all other appliances on: \_\_\_\_\_

Gas rate - Natural Gas - Time for 1 cubic foot in seconds: \_\_\_\_\_

Top or Rear Flue Installation: \_\_\_\_\_ Overall length of flue: \_\_\_\_\_

Is there any spillage: \_\_\_\_\_ Is the draught excessive: \_\_\_\_\_

Is there any permanent ventilation in the room: \_\_\_\_\_

Is the TTB connected correctly (both ends): \_\_\_\_\_

Is the aeration of the pilot correct: \_\_\_\_\_

Does the flame encircle the Thermocouple: \_\_\_\_\_

Installation Engineers Name:

\_\_\_\_\_

Installers \_\_\_\_\_

Address \_\_\_\_\_

\_\_\_\_\_

Post Code: \_\_\_\_\_

Telephone: \_\_\_\_\_

Fax: \_\_\_\_\_ Mobile: \_\_\_\_\_ Other: \_\_\_\_\_

Gas Safe Registration No:

\_\_\_\_\_

Signed: \_\_\_\_\_ Date: \_\_\_\_\_

## **Guarantee**

Your decorative gas fire, when installed in accordance with the installation instructions and operated in accordance with these instructions should provide many years of safe and efficient operation.

We thank you for purchasing our product and trust it will provide excellent service.

### **This appliance carries a manufacturer's guarantee of One (1) Year.**

The guarantee begins at the date of purchase. However should the appliance remain un-installed the guarantee period will commence six (6) months after the original purchase date.

Please note consumable items including the ceramic logs, Mica board and rope seals are not covered by this guarantee. The glass on the appliance is also not covered by any form of guarantee.

We agree to repair free of charge or, at our option, replace the appliance or part thereof, which may prove to be defective within the guarantee period.

The guarantee is void if:

- The appliance is not installed and operated in accordance with our instructions, or
- Repairs or modifications have been carried out by the purchaser or any third party not authorised by us or:
- The appliance has been misused or accidentally damaged, or
- Damage is due to 'fair wear and tear.' or
- The appliance or defective component(s) are not returned to us, prepaid postage.
- The appliance has not been serviced annually by a 'Gas Safe Registered' engineer.

The rights given in this guarantee are limited to the UK mainland and are in addition to any to which you may have a statutory entitlement.

Please retain your purchase receipt. We will need to see this in the event of a claim under warranty.

Broseley Fires LTD  
19-34 Bedesway,  
Bede Industrial Estate,  
Jarrow,  
Tyne and Wear,  
NE32 3BE.

Tel: (0191) 430 0901

Fax: (0191) 430 9522

<http://www.broseleyfires.com>

**UK UK**  
**CA NI**



# Energy Efficiency Rating

Top Flue Outlet

Rear Flue Outlet

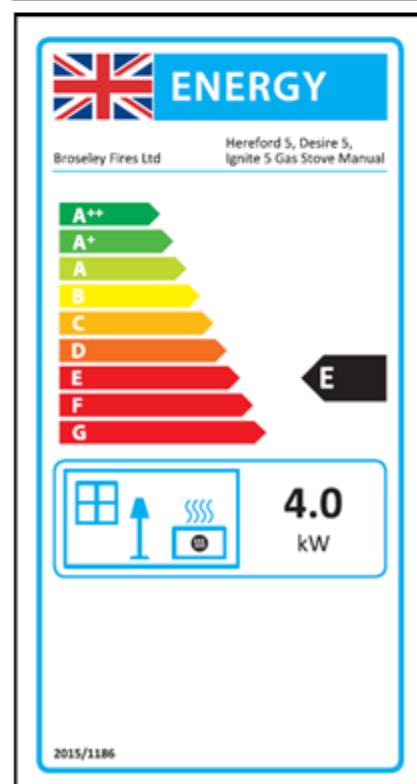
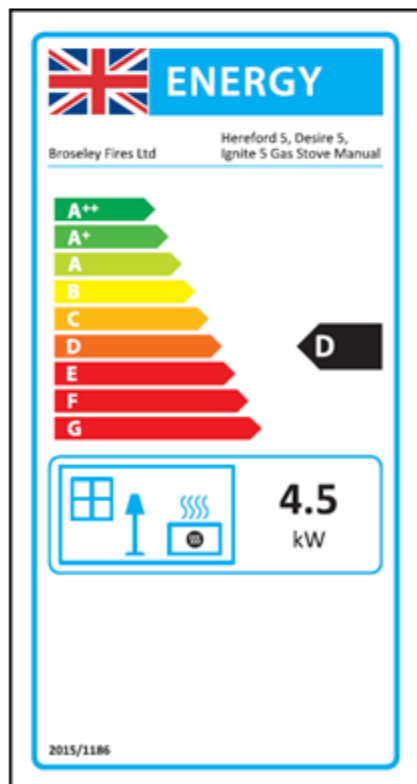
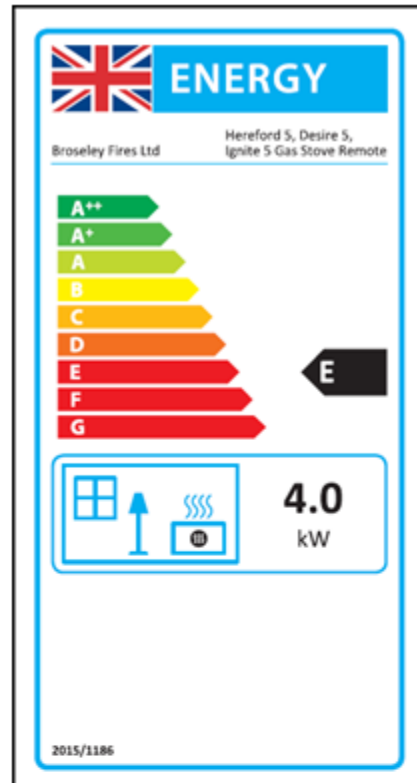
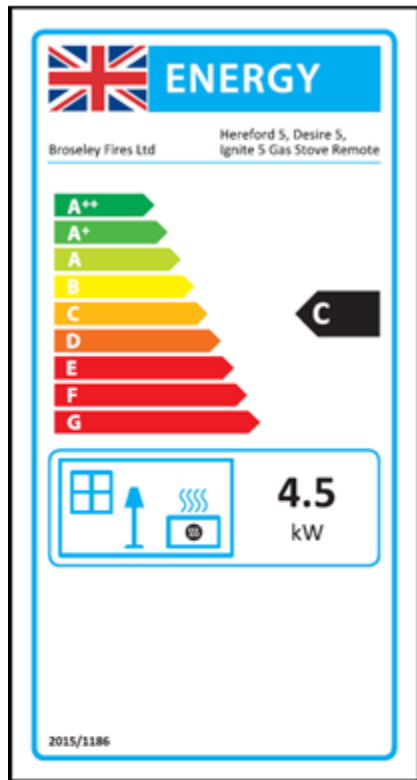

<b>Product Fiche</b>				
<b>Manufacturer : Broseley Fires Ltd</b>				
<b>Model No.</b>	<b>Hereford 5, Desire 5, Ignite 5 Remote Top Flue</b>	<b>Hereford 5, Desire 5, Ignite 5 Remote Rear Flue</b>	<b>Hereford 5, Desire 5, Ignite 5 Manual Top Flue</b>	<b>Hereford 5, Desire 5, Ignite 5 Manual Rear Flue</b>
<b>Fuel Type</b>	Natural Gas I2H	Natural Gas I2H	Natural Gas I2H	Natural Gas I2H
<b>Energy Efficiency Class</b>	C	E	D	E
<b>Indirect Heating Functionality</b>	No	No	No	No
<b>Direct Heat Output kW</b>	4.5kW	4.0kW	4.5kW	4.0kW
<b>Indirect Heat Output kW</b>	N/A	N/A	N/A	N/A
<b>EEI</b>	79%	70%	74%	65%
<b>Useful Energy Efficiency (NCV)</b>	High : 83%	High : 74%	High : 83%	High : 74%
<b>Useful Energy Efficiency (NCV)</b>	Low : N / A	Low : N / A	Low : N / A	Low : N / A
<b>Nominal Heat Output</b>	High : 4.5kW	High : 4.0kW	High : 4.5kW	High : 4.0kW
<b>Nominal Heat Output</b>	Low : 2.8kW	Low : 2.5kW	Low : 2.8kW	Low : 2.5kW
<b>Heat Output Temperature Control</b>	Electronic Room Temperature Control Plus day Timer	Electronic Room Temperature Control Plus day Timer	Two Manual Stages	Two Manual Stages
<b>Permanent Pilot Power (kW)</b>	N/A	N/A	N/A	N/A
<b>Space Heating Emissions NOx (GCV)</b>	130mg/kWh	130mg/kWh	130mg/kWh	130mg/kWh

### **Important Note:**

The energy efficiency class of this product is defined using a seasonal efficiency calculation which reduces the actual net efficiency of the product where the use of automated heat control, thermostats, window open sensors and timers are not used. This is not to be confused with the net efficiency, or useful efficiency of the appliance (shown in the tables above).

**This product MUST be installed by a Gas Safe Registered Installer. Full details are provided in this manual.**

**Broseley Fires Ltd, 19-34 Bedesway, Bede Industrial Estate, Jarrow, Tyne and Wear, NE32 3BE.**