

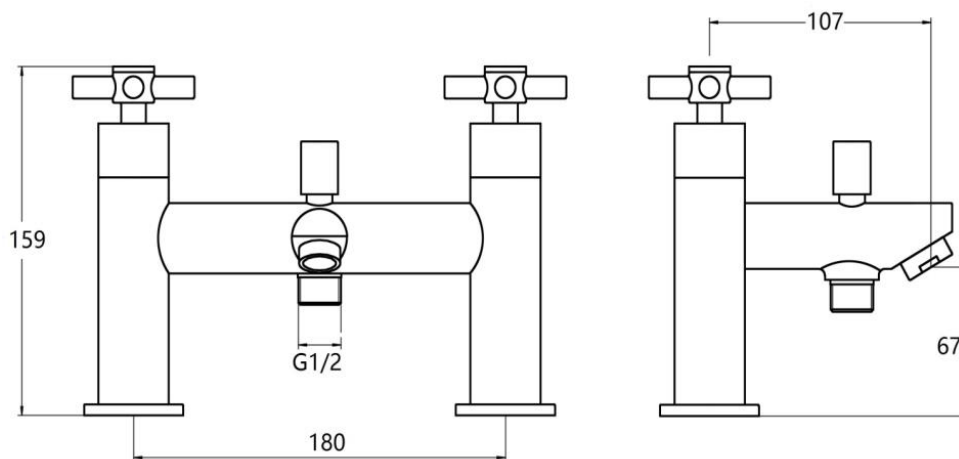

Diagrams not to scale.
All dimensions in mm tolerance of +/- 2mm



Unit Weight:	2.13Kg
Fitting:	Brass G3/4" BSP tails
Water Pressure:	Min. 0.5 bar, Max. 6.0 bar

Specification:

- Suitable for all plumbing systems, Hot and Cold water pressure preferably balanced Max. supply pressure differential requirement no greater than 5:1
- 10 years against manufacturing faults (excluding serviceable parts)
- Construction: Brass Body (CuZn40Pb2), EN CW617N (equivalent to BS CZ122) Zinc-alloy Handles

Finish

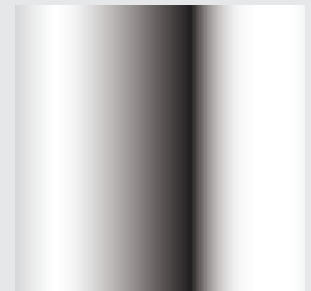

Chrome